



Philips CoreLine paneel: eenvoudige installatie, uitstekende verlichting

CoreLine Paneel gen6

Philips CoreLine paneel Gen6 maakt de CoreLine-beloofte van innovatie, eenvoudige installatie en uitstekende verlichting meer dan waar. De innovatieve Alles-in-een-functie van deze LED-paneelverlichting biedt keuze uit drie lichtopbrengsten en drie kleurtemperaturen in één armatuur. Dit maakt het eenvoudig om het juiste product te selecteren, geeft je de flexibiliteit om ter plaatse in te spelen op de voorkeuren van de klant en zorgt ervoor dat je minder productcodes op voorraad hoeft te houden. De installatie van dit CoreLine RC132V LED-paneel is snel en eenvoudig, dankzij de snelkoppeling of FlyWire van het product. De CoreLine portfolio bevat ook Interact Ready armaturen met geïntegreerde draadloze communicatie, klaar om te worden gebruikt met Interact gateways, sensoren en software.

Voordelen

- Bedrijfszekere producten met laag risico
- Werk sneller met deze eenvoudig te installeren producten
- Geen verwarring dankzij eenvoudige productselectie
- Blijf bij met IoT en slimme verlichtingssystemen

CoreLine Paneel gen6

Kenmerken

- L90 bij 50.000 uur/ L80 bij 100.000 uur met 5 jaar garantie
- Snelkoppeling (groen/wit, Flywire, WAGO en Schuko)
- Hoge lichtopbrengst, in uitvoeringen die wel en niet aan kantoornormen voldoen
- CRI 80/CRI 90 bij SDCM <3
- CRI 80 4000 K 140 lm/Wand 3000 K > 130 lm/W, CRI 90 >115 lm/W
- UltraEfficient 4000 K >160 lm/W
- Alles-in-een: meerdere lichtopbrengsten en kleurtemperaturen in één armatuur

Toepassing

- Kantoren
- Gezondheidszorg
- Gemeentelijke gebouwen
- Onderwijs

Versions

CoreLine panel G6 W60L60 IP65



Philips CoreLine panel G6 All in MultiLumen W60L60



CoreLine panel G6 PSU W30L120
SIA Sensor RTP



Maatschets

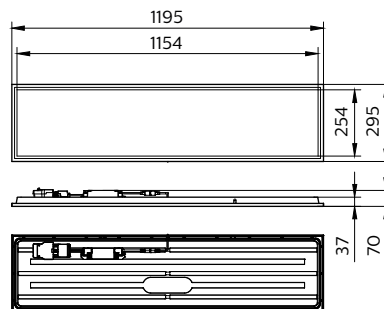
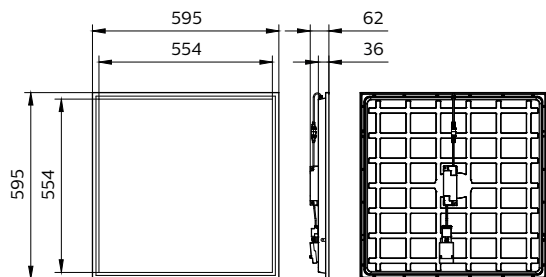

CoreLine Paneel gen6

Maatschets

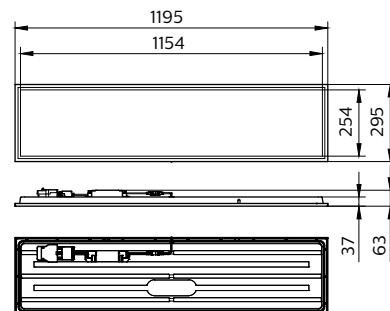
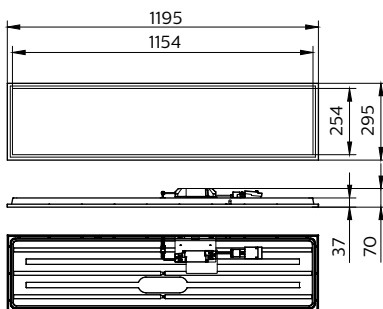
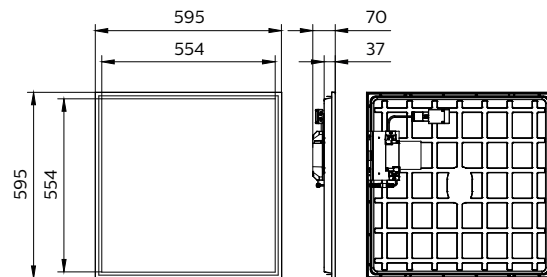
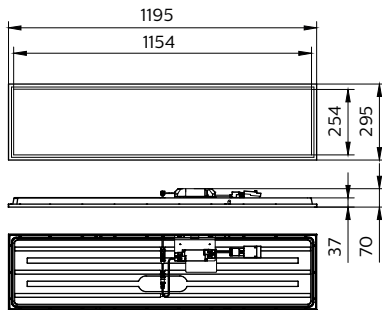
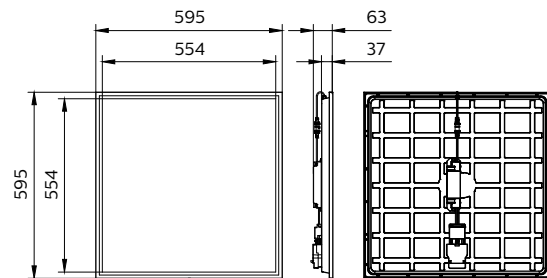
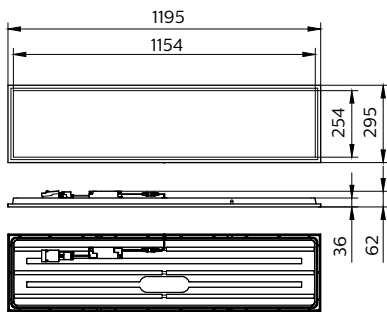
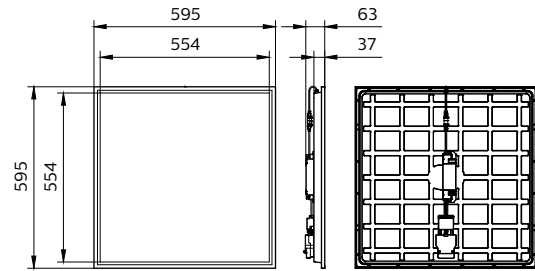
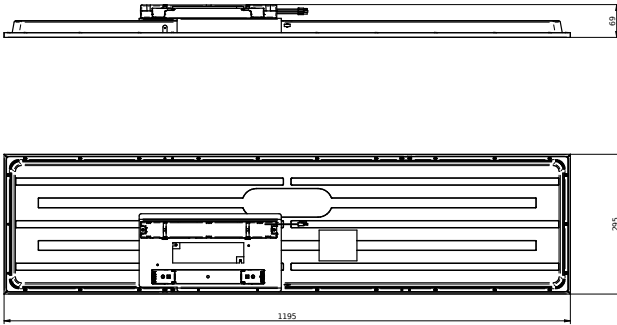

CoreLine Paneel gen6

Maatschets

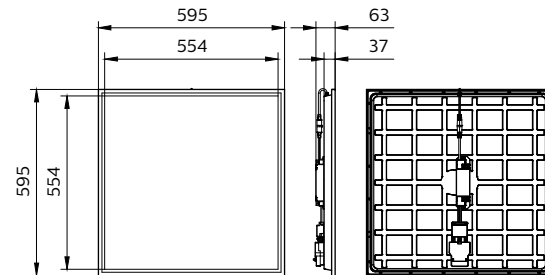
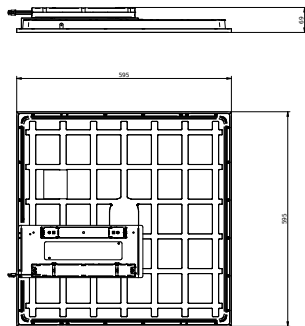
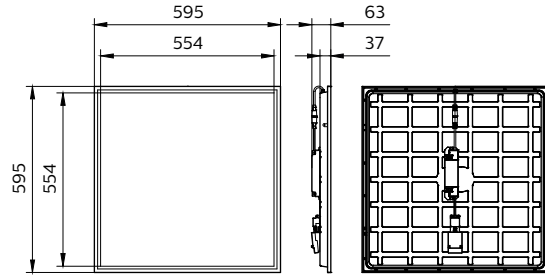
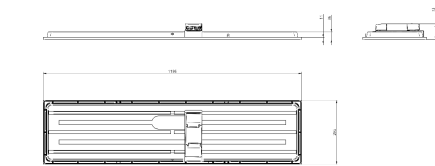
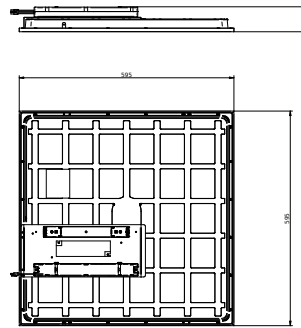
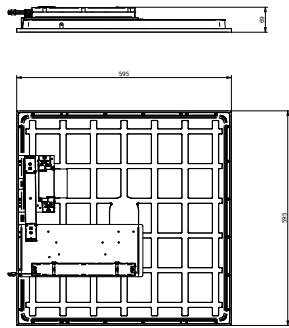
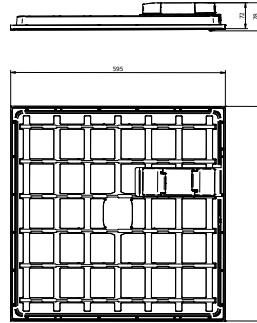
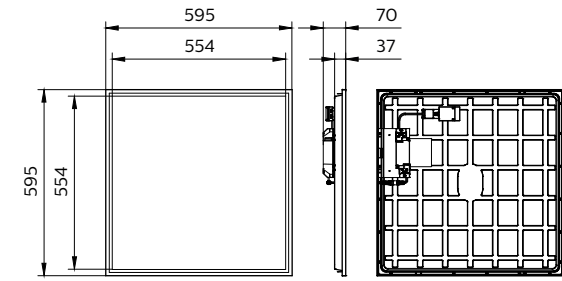

CoreLine Paneel gen6

Maatschets

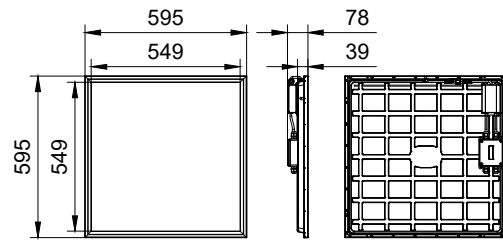
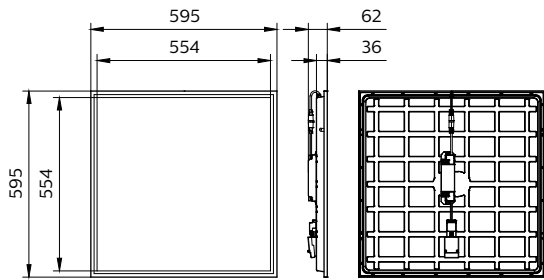
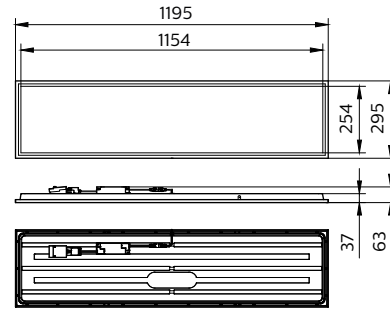
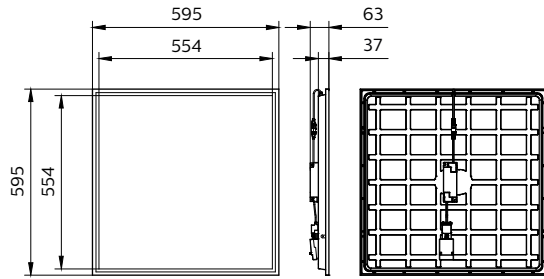

Productgegevens



CoreLine panel G6 PSU Green
connector fits Wieland W3
connector



CoreLine panel G6 PSU W60L60
back side DPP



CoreLine panel G6 PSU W30L120
SIA Sensor back side DPP

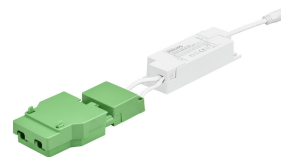

CoreLine panel G6 PSU driver DPP

CoreLine Paneel gen6

Productgegevens



CoreLine panel G6 WIA back side
DPP



CoreLine panel G6 PSU W30L120
back side DPP



CoreLine panel G6 PSD W30L120
back side DPP

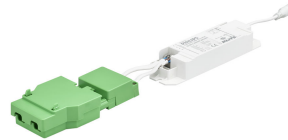

CoreLine panel G6 PSD driver
open DPP



CoreLine panel G6 PSD All in
W60L60 back side DPP



CoreLine panel G6 IP65 PSD driver

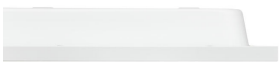

CoreLine panel G6 side angle DPP



CoreLine panel G6 WIA driver DPP



CoreLine panel G6 NOC Optical
window DPP

CoreLine Paneel gen6

Productgegevens

CoreLine panel G6 All in driver
open DPP



CoreLine panel G6 All in driver
DPP



CoreLine panel G6 PSU driver
open DPP

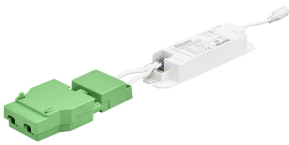

CoreLine panel G6 PSD W60L60
back side DPP



CoreLine panel G6 IP65 PSD back
side



CoreLine panel G6 W60L60 OC
Optical window DPP



CoreLine panel G6 PSD driver DPP

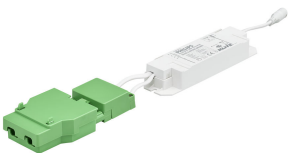

CoreLine Paneel gen6

Algemene informatie	
Driver/VSA inbegrepen	Ja
Aantal VSA's	1 unit
Bedrijfs- en elektrische gegevens	
IEC beschermingsklasse	Veiligheidsklasse II
Werking op noodstroom	
Centrale noodpost	Nee
Keurmerken en classificaties	
CE-markering	Ja
ENEC-markering	ENEC-markering
Flikkerwaarde (PstLM)	1
Stroboscoopeffectwaarde (SVM)	0,4
Initiële prestaties (conform IEC)	
Tolerantie lichtstroom	-10% / +10%

Algemene informatie

Order Code	Full Product Name	Servicetag
8720169588592	RC132V G6 43S/840 SIA W60L60 OC IA4	Ja
8720169588608	RC132V G6 40S/830 SIA W60L60 OC IA4	Ja
8720169749894	RC132V G6 29_36_43S/830_40 PSDW30L120OC	Ja
8720169751323	RC132V G6 40_43S/830_40 WIA 30x120 OC	Ja
8720169588769	RC132V G6 36S/840 PSU W30L120 OC ELB3	Ja
8720169750067	RC132V G6 36S/840 WIA W30L120 OC	Ja
8720169735118	RC132V G6 36S/840 PSU W30L120 NOC	Ja
8720169735149	RC132V G6 36S/840 PSU W30L120 OC	Ja
8720169735170	RC132V G6 36S/840 PSD W30L120 OC	Ja
8720169735620	RC132V G6 48S/940 PSD W60L60 OC IP65	Ja
8720169588738	RC132V G6 36S/840 PSU W60L60 OC ELB3	Ja
8720169588745	RC132V G6 36S/840 PSD W60L60 OC ELB3	Ja
8720169588752	RC132V G6 36S/840 WIA W60L60 OC ELB3	Ja
8720169749818	RC132V G6 36S/UE840 PSU W60L60 NOC	Ja
8720169749825	RC132V G6 36S/UE840 PSU W60L60 OC	Ja
8720169749832	RC132V G6 36S/UE840 PSD W60L60 OC	Ja
8720169749849	RC132V G6 50S/840 PSD W60L60 OC	Ja
8720169749993	RC132V G6 34S/830 WIA W60L60 OC	Ja
8720169750005	RC132V G6 36S/840 WIA W60L60 OC	Ja
8720169750029	RC132V G6 43S/840 WIA W60L60 OC	Ja
8720169751309	RC132V G6 36S/UE840 WIA W60L60 OC	Ja
8720169751330	RC132V G6 34S/830 PSU W60L60 NOC	Ja
8720169751347	RC132V G6 34S/830 PSU W60L60 OC	Ja
8720169735095	RC132V G6 36S/840 PSU W60L60 NOC	Ja
8720169735125	RC132V G6 36S/840 PSU W60L60 OC	Ja
8720169735156	RC132V G6 36S/840 PSD W60L60 OC	Ja
8720169749955	RC132V G6 31_36_43S/940 PSD W60L60 OC	Ja
8720169835238	RC132V G6 43S/840 SIA W30L120 OC IA4	-
8720169749900	RC132V G6 29_36_43S/830_40 PSU W60L60NOC	Ja
8720169751316	RC132V G6 40_43S/830_40 WIA 60x60 OC	Ja
8720169735187	RC132V G6 29_36_43S/830_40 PSU W60L60 OC	Ja
8720169735194	RC132V G6 29_36_43S/830_40 PSD W60L60 OC	Ja

Gegevens lichttechniek (1/2)

Order Code	Full Product Name	Gecorreleerde				Order Code	Full Product Name	Gecorreleerde			
		Alles-in-één type	Bundelhoek lichtbron	kleurtemperatuur (nom.)	Kleurwee index (CR)			Alles-in-één type	Bundelhoek lichtbron	kleurtemperatuur (nom.)	Kleurweegave-index (CRI)
8720169588592	RC132V G6 43S/840 SIA W60L60 OC IA4	-	90 graden	4000 K	>80	8720169751323	RC132V G6 40_43S/830_40 WIA 30x120 OC Temperature	All-in, Multi	90 graden	3000 K	>80
8720169588608	RC132V G6 40S/830 SIA W60L60 OC IA4	-	90 graden	3000 K	>80	8720169588769	RC132V G6 36S/840 PSU W30L120 OC ELB3	-	90 graden	4000 K	>80
8720169749894	RC132V G6 29_36_43S/830_40 PSDW30L120OC	All-in, Multi Lumen	90 graden	3000 K	>80	8720169750067	RC132V G6 36S/840 WIA W30L120 OC	-	90 graden	4000 K	>80

CoreLine Paneel gen6

Order Code	Full Product Name	Alles-in-één type	Gecorreleerde			Order Code	Full Product Name	Alles-in-één type	Gecorreleerde		
			Bundelhoek lichtbron	kleurtemperatuur (nom.)	Kleurwee index (CR)				Bundelhoek lichtbron	kleurtemperatuur (nom.)	Kleurweegave-index (CRI)
8720169735118	RC132V G6 36S/840 PSU W30L120 NOC	-	120 graden	4000 K	>80	8720169751309	RC132V G6 36S/ UE840 WIA W60L60 OC	-	90 graden	4000 K	>80
8720169735149	RC132V G6 36S/840 PSU W30L120 OC	-	90 graden	4000 K	>80	8720169751330	RC132V G6 34S/830 PSU W60L60 NOC	-	120 graden	3000 K	>80
8720169735170	RC132V G6 36S/840 PSD W30L120 OC	-	90 graden	4000 K	>80	8720169751347	RC132V G6 34S/830 PSU W60L60 OC	-	90 graden	3000 K	>80
8720169735620	RC132V G6 48S/940 PSD W60L60 OC IP65	-	90 graden	4000 K	>90	8720169735095	RC132V G6 36S/840 PSU W60L60 NOC	-	120 graden	4000 K	>80
8720169588738	RC132V G6 36S/840 PSU W60L60 OC ELB3	-	90 graden	4000 K	>80	8720169735125	RC132V G6 36S/840 PSU W60L60 OC	-	90 graden	4000 K	>80
8720169588745	RC132V G6 36S/840 PSD W60L60 OC ELB3	-	90 graden	4000 K	>80	8720169735156	RC132V G6 36S/840 PSD W60L60 OC	-	90 graden	4000 K	>80
8720169588752	RC132V G6 36S/840 WIA W60L60 OC ELB3	-	90 graden	4000 K	>80	8720169749955	RC132V G6 31_36_43S/940 PSD W60L60 OC	All-in, Multi Lumen	90 graden	4000 K	>90
8720169749818	RC132V G6 36S/ UE840 PSU W60L60 NOC	-	120 graden	4000 K	>80	8720169835238	RC132V G6 43S/840 SIA W30L120 OC IA4	-	90 graden	4000 K	>80
8720169749825	RC132V G6 36S/ UE840 PSU W60L60 OC	-	90 graden	4000 K	>80	8720169749900	RC132V G6 29_36_43S/ 830_40 PSU W60L60NOC	All-in, Multi Lumen	120 graden	3000 K	>80
8720169749832	RC132V G6 36S/ UE840 PSD W60L60 OC	-	90 graden	4000 K	>80	8720169751316	RC132V G6 40_43S/830_40 WIA 60x60 OC	All-in, Multi Color Temperature	90 graden	3000 K	>80
8720169749849	RC132V G6 50S/840 PSD W60L60 OC	-	90 graden	4000 K	>80	8720169735187	RC132V G6 29_36_43S/ 830_40 PSU W60L60 OC	All-in, Multi Lumen	90 graden	3000 K	>80
8720169749993	RC132V G6 34S/830 WIA W60L60 OC	-	90 graden	3000 K	>80	8720169735194	RC132V G6 29_36_43S/ 830_40 PSD W60L60 OC	All-in, Multi Lumen	90 graden	3000 K	>80
8720169750005	RC132V G6 36S/840 WIA W60L60 OC	-	90 graden	4000 K	>80						
8720169750029	RC132V G6 43S/840 WIA W60L60 OC	-	90 graden	4000 K	>80						

Gegevens lichttechniek (2/2)

CoreLine Paneel gen6

Order Code	Full Product Name	Lichtrendement		
		(gespec.) (nom.)	Lichtstroom	Optiektype
8720169588592	RC132V G6 43S/840 SIA W60L60 OC IA4	132 lm/W	4.300 lm	Bundelhoek 90°
8720169588608	RC132V G6 40S/830 SIA W60L60 OC IA4	126 lm/W	4.000 lm	Bundelhoek 90°
8720169749894	RC132V G6 29_36_43S/830_40 PSDW30L120OC	141 lm/W	2.900 lm	Bundelhoek 90°
8720169751323	RC132V G6 40_43S/ 830_40 WIA 30x120 OC	139 lm/W	4.000 lm	Bundelhoek 90°
8720169588769	RC132V G6 36S/840 PSU W30L120 OC ELB3	110 lm/W	3.600 lm	Bundelhoek 90°
8720169750067	RC132V G6 36S/840 WIA W30L120 OC	138 lm/W	3.600 lm	Bundelhoek 90°
8720169735118	RC132V G6 36S/840 PSU W30L120 NOC	138 lm/W	3.600 lm	Bundelhoek 120°
8720169735149	RC132V G6 36S/840 PSU W30L120 OC	138 lm/W	3.600 lm	Bundelhoek 90°
8720169735170	RC132V G6 36S/840 PSD W30L120 OC	138 lm/W	3.600 lm	Bundelhoek 90°
8720169735620	RC132V G6 48S/940 PSD W60L60 OC IP65	107 lm/W	4.800 lm	Bundelhoek 90°
8720169588738	RC132V G6 36S/840 PSU W60L60 OC ELB3	110 lm/W	3.600 lm	Bundelhoek 90°
8720169588745	RC132V G6 36S/840 PSD W60L60 OC ELB3	110 lm/W	3.600 lm	Bundelhoek 90°
8720169588752	RC132V G6 36S/840 WIA W60L60 OC ELB3	110 lm/W	3.600 lm	Bundelhoek 90°
8720169749818	RC132V G6 36S/ UE840 PSU W60L60 NOC	160 lm/W	3.600 lm	Bundelhoek 120°
8720169749825	RC132V G6 36S/ UE840 PSU W60L60 OC	160 lm/W	3.600 lm	Bundelhoek 90°
8720169749832	RC132V G6 36S/ UE840 PSD W60L60 OC	153 lm/W	3.600 lm	Bundelhoek 90°

Order Code	Full Product Name	Lichtrendement		
		(gespec.) (nom.)	Lichtstroom	Optiektype
8720169749849	RC132V G6 50S/840 PSD W60L60 OC	132 lm/W	5.000 lm	Bundelhoek 90°
8720169749993	RC132V G6 34S/830 WIA W60L60 OC	131 lm/W	3.400 lm	Bundelhoek 90°
8720169750005	RC132V G6 36S/840 WIA W60L60 OC	138 lm/W	3.600 lm	Bundelhoek 90°
8720169750029	RC132V G6 43S/840 WIA W60L60 OC	139 lm/W	4.300 lm	Bundelhoek 90°
8720169751309	RC132V G6 36S/ UE840 WIA W60L60 OC	153 lm/W	3.600 lm	Bundelhoek 90°
8720169751330	RC132V G6 34S/830 PSU W60L60 NOC	131 lm/W	3.400 lm	Bundelhoek 120°
8720169751347	RC132V G6 34S/830 PSU W60L60 OC	131 lm/W	3.400 lm	Bundelhoek 90°
8720169735095	RC132V G6 36S/840 PSU W60L60 NOC	138 lm/W	3.600 lm	Bundelhoek 120°
8720169735125	RC132V G6 36S/840 PSU W60L60 OC	138 lm/W	3.600 lm	Bundelhoek 90°
8720169735156	RC132V G6 36S/840 PSD W60L60 OC	138 lm/W	3.600 lm	Bundelhoek 90°
8720169749955	RC132V G6 31_36_43S/940 PSD W60L60 OC	119 lm/W	3.100 lm	Bundelhoek 90°
8720169835238	RC132V G6 43S/840 SIA W30L120 OC IA4	132 lm/W	4.300 lm	Bundelhoek 90°
8720169749900	RC132V G6 29_36_43S/830_40 PSU W60L60NOC	141 lm/W	2.900 lm	Bundelhoek 120°
8720169751316	RC132V G6 40_43S/ 830_40 WIA 60x60 OC	139 lm/W	4.000 lm	Bundelhoek 90°
8720169735187	RC132V G6 29_36_43S/830_40 PSU W60L60 OC	141 lm/W	2.900 lm	Bundelhoek 90°
8720169735194	RC132V G6 29_36_43S/830_40 PSD W60L60 OC	141 lm/W	2.900 lm	Bundelhoek 90°

Bedrijfs- en elektrische gegevens

CoreLine Paneel gen6

Order Code	Full Product Name	Ingangsspanning	Ingangsfrequentie	Energieverbruik	Order Code	Full Product Name	Ingangsspanning	Ingangsfrequentie	Energieverbruik	Geschiktheid voor willekeurige schakelvervals
8720169588592	RC132V G6 43S/840 SIA W60L60 OC IA4	220 tot 240 V	50 or 60 Hz	32 W	8720169749825	RC132V G6 36S/ UE840 PSU W60L60 OC	220 tot 240 V	50 or 60 Hz	22,5 W	Niet van toepassing
8720169588608	RC132V G6 40S/830 SIA W60L60 OC IA4	220 tot 240 V	50 or 60 Hz	32 W	8720169749832	RC132V G6 36S/ UE840 PSD W60L60 OC	220 tot 240 V	50 or 60 Hz	23,5 W	Niet van toepassing
8720169749894	RC132V G6 29_36_43S/ 830_40 PSDW30L120OC	220 tot 240 V	50 or 60 Hz	31 W	8720169749849	RC132V G6 50S/840 PSD W60L60 OC	220 tot 240 V	50 or 60 Hz	38 W	Niet van toepassing
8720169751323	RC132V G6 40_43S/830_40 WIA 30x120 OC	220 tot 240 V	50 or 60 Hz	31 W	8720169749993	RC132V G6 34S/830 WIA W60L60 OC	220 tot 240 V	50 or 60 Hz	26 W	Niet van toepassing
8720169588769	RC132V G6 36S/840 PSU W30L120 OC ELB3	220 tot 240 V	50 or 60 Hz	27 W	8720169750005	RC132V G6 36S/840 WIA W60L60 OC	220 tot 240 V	50 or 60 Hz	26 W	Niet van toepassing
8720169750067	RC132V G6 36S/840 WIA W30L120 OC	220 tot 240 V	50 or 60 Hz	26 W	8720169750029	RC132V G6 43S/840 WIA W60L60 OC	220 tot 240 V	50 or 60 Hz	31 W	Niet van toepassing
8720169735118	RC132V G6 36S/840 PSU W30L120 NOC	220 tot 240 V	50 or 60 Hz	26 W	8720169751309	RC132V G6 36S/ UE840 WIA W60L60 OC	220 tot 240 V	50 or 60 Hz	23,5 W	Niet van toepassing
8720169735149	RC132V G6 36S/840 PSU W30L120 OC	220 tot 240 V	50 or 60 Hz	26 W	8720169751330	RC132V G6 34S/830 PSU W60L60 NOC	220 tot 240 V	50 or 60 Hz	26 W	Niet van toepassing
8720169735170	RC132V G6 36S/840 PSD W30L120 OC	220 tot 240 V	50 or 60 Hz	26 W	8720169751347	RC132V G6 34S/830 PSU W60L60 OC	220 tot 240 V	50 or 60 Hz	26 W	Niet van toepassing
8720169735620	RC132V G6 48S/940 PSD W60L60 OC IP65	220 tot 240 V	50 or 60 Hz	45 W	8720169735095	RC132V G6 36S/840 PSU W60L60 NOC	220 tot 240 V	50 or 60 Hz	26 W	Niet van toepassing
8720169588738	RC132V G6 36S/840 PSU W60L60 OC ELB3	220 tot 240 V	50 or 60 Hz	27 W	8720169735125	RC132V G6 36S/840 PSU W60L60 OC	220 tot 240 V	50 or 60 Hz	26 W	Niet van toepassing
8720169588745	RC132V G6 36S/840 PSD W60L60 OC ELB3	220 tot 240 V	50 or 60 Hz	27 W	8720169735156	RC132V G6 36S/840 PSD W60L60 OC	220 tot 240 V	50 or 60 Hz	26 W	Niet van toepassing
8720169588752	RC132V G6 36S/840 WIA W60L60 OC ELB3	220 tot 240 V	50 or 60 Hz	27 W	8720169749955	RC132V G6 31_36_43S/940 PSD W60L60 OC	220 tot 240 V	50 or 60 Hz	38 W	Niet van toepassing
8720169749818	RC132V G6 36S/ UE840 PSU W60L60 NOC	220 tot 240 V	50 or 60 Hz	22,5 W	8720169835238	RC132V G6 220-240 V 50 to 60 Hz 32 W	220-240 V	50 to 60 Hz	32 W	Nee
					8720169749900	RC132V G6 43S/840 SIA W30L120 OC IA4	220 tot 240 V	50 or 60 Hz	31 W	Niet van toepassing
					8720169749900	RC132V G6 29_36_43S/ 830_40 PSU W60L60NOC	220 tot 240 V	50 or 60 Hz	31 W	Niet van toepassing

CoreLine Paneel gen6

Order Code	Full Product Name	Ingangsspanning	Ingangsfrequentie	Energieverbruik	Order Code	Full Product Name	Ingangsspanning	Ingangsfrequentie	Energieverbruik	Geschiktheid voor willekeurige toepassingen
8720169751316	RC132V G6 40_43S/830_40 WIA 60x60 OC	220 tot 240 V	50 or 60 Hz	31 W	Niet van toepassing	830_40 PSU W60L60 OC				
8720169735187	RC132V G6 29_36_43S/	220 tot 240 V	50 or 60 Hz	31 W	Niet van toepassing	29_36_43S/ 830_40 PSD W60L60 OC	220 tot 240 V	50 or 60 Hz	31 W	Niet van toepassing

Dimbaarheid en regelsystemen

Order Code	Full Product Name	Dimbaar	Ingebouwde regeling	Maximaal dimniveau	Order Code	Full Product Name	Dimbaar	Ingebouwde regeling	Maximaal dimniveau
8720169588592	RC132V G6 43S/840 SIA W60L60 OC IA4	Ja	Interact SNS210-sensor	Niet van toepassing	8720169749849	RC132V G6 50S/840 PSD W60L60 OC	Ja	-	1%
8720169588608	RC132V G6 40S/830 SIA W60L60 OC IA4	Ja	Interact SNS210-sensor	Niet van toepassing	8720169749993	RC132V G6 34S/830 WIA W60L60 OC	Ja	-	1%
8720169749894	RC132V G6 29_36_43S/ 830_40 PSDW30L120OC	Ja	-	1%	8720169750005	RC132V G6 36S/840 WIA W60L60 OC	Ja	-	1%
8720169751323	RC132V G6 40_43S/830_40 WIA 30x120 OC	Ja	-	1%	8720169750029	RC132V G6 43S/840 WIA W60L60 OC	Ja	-	1%
8720169588769	RC132V G6 36S/840 PSU W30L120 OC ELB3	Nee	-	Niet van toepassing	8720169751309	RC132V G6 36S/UE840 WIA W60L60 OC	Ja	-	1%
8720169750067	RC132V G6 36S/840 WIA W30L120 OC	Ja	-	1%	8720169751330	RC132V G6 34S/830 PSU W60L60 NOC	Nee	-	Niet van toepassing
8720169735118	RC132V G6 36S/840 PSU W30L120 NOC	Nee	-	Niet van toepassing	8720169751347	RC132V G6 34S/830 PSU W60L60 OC	Nee	-	Niet van toepassing
8720169735149	RC132V G6 36S/840 PSU W30L120 OC	Nee	-	Niet van toepassing	8720169735095	RC132V G6 36S/840 PSU W60L60 NOC	Nee	-	Niet van toepassing
8720169735170	RC132V G6 36S/840 PSD W30L120 OC	Ja	-	1%	8720169735125	RC132V G6 36S/840 PSU W60L60 OC	Nee	-	Niet van toepassing
8720169735620	RC132V G6 48S/940 PSD W60L60 OC IP65	Ja	-	1%	8720169735156	RC132V G6 36S/840 PSD W60L60 OC	Ja	-	1%
8720169588738	RC132V G6 36S/840 PSU W60L60 OC ELB3	Nee	-	Niet van toepassing	8720169749955	RC132V G6 31_36_43S/940 PSD W60L60 OC	Ja	-	1%
8720169588745	RC132V G6 36S/840 PSD W60L60 OC ELB3	Ja	-	10%	8720169835238	RC132V G6 43S/840 SIA W30L120 OC IA4	Ja	Interact SNS210-sensor	Niet van toepassing
8720169588752	RC132V G6 36S/840 WIA W60L60 OC ELB3	Ja	-	10%	8720169749900	RC132V G6 29_36_43S/ 830_40 PSU W60L60NOC	Nee	-	Niet van toepassing
8720169749818	RC132V G6 36S/UE840 PSU W60L60 NOC	Nee	-	Niet van toepassing	8720169751316	RC132V G6 40_43S/830_40 WIA 60x60 OC	Ja	-	1%
8720169749825	RC132V G6 36S/UE840 PSU W60L60 OC	Nee	-	Niet van toepassing	8720169735187	RC132V G6 29_36_43S/ 830_40 PSU W60L60 OC	Nee	-	Niet van toepassing
8720169749832	RC132V G6 36S/UE840 PSD W60L60 OC	Ja	-	1%	8720169735194	RC132V G6 29_36_43S/ 830_40 PSD W60L60 OC	Ja	-	1%

Eigenschappen behuizing en afmetingen

CoreLine Paneel gen6

Order Code	Full Product Name	Kleur behuizing	IK- classificatie	Beschermingsklasse
8720169588592	RC132V G6 43S/840 SIA W60L60 OC IA4	Wit	IK02	IP 20
8720169588608	RC132V G6 40S/830 SIA W60L60 OC IA4	Wit	IK02	IP 20
8720169749894	RC132V G6 29_36_43S/830_40 PSDW30L120OC	Wit	IK02	IP 20/44
8720169751323	RC132V G6 40_43S/ 830_40 WIA 30x120 OC	Wit	IK02	IP 20/44
8720169588769	RC132V G6 36S/840 PSU W30L120 OC ELB3	Wit	IK03	IP 20/44
8720169750067	RC132V G6 36S/840 WIA W30L120 OC	Wit	IK02	IP 20/44
8720169735118	RC132V G6 36S/840 PSU W30L120 NOC	Wit	IK03	IP 20/44
8720169735149	RC132V G6 36S/840 PSU W30L120 OC	Wit	IK02	IP 20/44
8720169735170	RC132V G6 36S/840 PSD W30L120 OC	Wit	IK02	IP 20/44
8720169735620	RC132V G6 48S/940 PSD W60L60 OC IP65	Wit	IK03	IP 65
8720169588738	RC132V G6 36S/840 PSU W60L60 OC ELB3	Wit	IK03	IP 20/44
8720169588745	RC132V G6 36S/840 PSD W60L60 OC ELB3	Wit	IK03	IP 20/44
8720169588752	RC132V G6 36S/840 WIA W60L60 OC ELB3	Wit	IK03	IP 20/44
8720169749818	RC132V G6 36S/ UE840 PSU W60L60 NOC	Wit	IK03	IP 20/44
8720169749825	RC132V G6 36S/ UE840 PSU W60L60 OC	Wit	IK02	IP 20/44
8720169749832	RC132V G6 36S/ UE840 PSD W60L60 OC	Wit	IK02	IP 20/44

Order Code	Full Product Name	Kleur behuizing	IK- classificatie	Beschermingsklasse
8720169749849	RC132V G6 50S/840 PSD W60L60 OC	Wit	IK02	IP 20/44
8720169749993	RC132V G6 34S/830 WIA W60L60 OC	Wit	IK02	IP 20/44
8720169750005	RC132V G6 36S/840 WIA W60L60 OC	Wit	IK02	IP 20/44
8720169750029	RC132V G6 43S/840 WIA W60L60 OC	Wit	IK02	IP 20/44
8720169751309	RC132V G6 36S/ UE840 WIA W60L60 OC	Wit	IK02	IP 20/44
8720169751330	RC132V G6 34S/830 PSU W60L60 NOC	Wit	IK03	IP 20/44
8720169751347	RC132V G6 34S/830 PSU W60L60 OC	Wit	IK02	IP 20/44
8720169735095	RC132V G6 36S/840 PSU W60L60 NOC	Wit	IK03	IP 20/44
8720169735125	RC132V G6 36S/840 PSU W60L60 OC	Wit	IK02	IP 20/44
8720169735156	RC132V G6 36S/840 PSD W60L60 OC	Wit	IK02	IP 20/44
8720169749955	RC132V G6 31_36_43S/940 PSD W60L60 OC	Wit	IK02	IP 20/44
8720169835238	RC132V G6 43S/840 SIA W30L120 OC IA4	Staal	IK02	IP 20
8720169749900	RC132V G6 29_36_43S/830_40 PSU W60L60NOC	Wit	IK03	IP 20/44
8720169751316	RC132V G6 40_43S/ 830_40 WIA 60x60 OC	Wit	IK02	IP 20/44
8720169735187	RC132V G6 29_36_43S/830_40 PSU W60L60 OC	Wit	IK02	IP 20/44
8720169735194	RC132V G6 29_36_43S/830_40 PSD W60L60 OC	Wit	IK02	IP 20/44

Werking op noodstroom

CoreLine Paneel gen6

Order Code	Full Product Name	Noodverlichting	Noodstroom	Type batterij voor noodverlichting	Gespeci levensduur de noodver opgelac (indien opgeladen)	Order Code	Full Product Name	Noodverlichting	Noodstroom	Type batterij voor noodverlichting	Gespecificeerd levensduur van de noodverlichting (indien volledig opgeladen)
8720169588592	RC132V G6 43S/840 SIA W60L60 OC IA4	-	-	-	-	8720169749818	RC132V G6 36S/ UE840 PSU W60L60 NOC	-	-	-	-
8720169588608	RC132V G6 40S/830 SIA W60L60 OC IA4	-	-	-	-	8720169749825	RC132V G6 36S/ UE840 PSU W60L60 OC	-	-	-	-
8720169749894	RC132V G6 29_36_43S/ 830_40 PSDW30L120OC	-	-	-	-	8720169749832	RC132V G6 36S/ UE840 PSD W60L60 OC	-	-	-	-
8720169751323	RC132V G6 40_43S/830_40 WIA 30x120 OC	-	-	-	-	8720169749849	RC132V G6 50S/840 PSD W60L60 OC	-	-	-	-
8720169588769	RC132V G6 36S/840 PSU W30L120 OC ELB3	Noodverlichting gedurende 3 uur, basisuitvoering	250 lm	Lithium	3 hr	8720169750005	RC132V G6 34S/830 WIA W60L60 OC	-	-	-	-
8720169750067	RC132V G6 36S/840 WIA W30L120 OC	-	-	-	-	8720169750029	RC132V G6 43S/840 WIA W60L60 OC	-	-	-	-
8720169735118	RC132V G6 36S/840 PSU W30L120 NOC	-	-	-	-	8720169751309	RC132V G6 36S/ UE840 WIA W60L60 OC	-	-	-	-
8720169735149	RC132V G6 36S/840 PSU W30L120 OC	-	-	-	-	8720169751330	RC132V G6 34S/830 PSU W60L60 NOC	-	-	-	-
8720169735170	RC132V G6 36S/840 PSD W30L120 OC	-	-	-	-	8720169751347	RC132V G6 34S/830 PSU W60L60 OC	-	-	-	-
8720169735620	RC132V G6 48S/940 PSD W60L60 OC IP65	-	-	-	-	8720169735095	RC132V G6 36S/840 PSU W60L60 NOC	-	-	-	-
8720169588738	RC132V G6 36S/840 PSU W60L60 OC ELB3	Noodverlichting gedurende 3 uur, basisuitvoering	250 lm	Lithium	3 hr	8720169735125	RC132V G6 36S/840 PSU W60L60 OC	-	-	-	-
8720169588745	RC132V G6 36S/840 PSD W60L60 OC ELB3	Noodverlichting gedurende 3 uur, basisuitvoering	250 lm	Lithium	3 hr	8720169735156	RC132V G6 36S/840 PSD W60L60 OC	-	-	-	-
8720169588752	RC132V G6 36S/840 WIA W60L60 OC ELB3	Noodverlichting gedurende 3 uur, basisuitvoering	250 lm	Lithium	3 hr	8720169749955	RC132V G6 31_36_43S/940 PSD W60L60 OC	-	-	-	-
						8720169835238	RC132V G6 43S/840 SIA W30L120 OC IA4	-	-	-	-

CoreLine Paneel gen6

Order Code	Full Product Name	Noodverlichting	Noodstroom	Type batterij voor noodverlichting	Gespecificeerde levensduur de noodverlichting (indien opgeladen)	Order Code	Full Product Name	Noodverlichting	Noodstroom	Type batterij voor noodverlichting	Gespecificeerde levensduur van de noodverlichting (indien volledig opgeladen)
8720169751316	RC132V G6 40_43S/830_40 WIA 60x60 OC	-	-	-	-						
8720169735187	RC132V G6 29_36_43S/	-	-	-	-						

Keurmerken en classificaties

Order Code	Full Product Name	Bereik omgevingstemperatuur	Brandbaarheidsmarkering	Gloeiduur	Order Code	Full Product Name	Bereik omgevingstemperatuur	Brandbaarheidsmarkering	Gloeiduur
8720169588592	RC132V G6 43S/840 SIA W60L60 OC IA4	-10 tot +35 °C	Voor montage op normaal brandbare oppervlakken	Temperatuur 650 °C, duur 30 s	8720169588738	RC132V G6 36S/840 PSU W60L60 OC	0 °C t/m 35 °C	Voor montage op normaal brandbare oppervlakken	Temperatuur 850 °C, duur 30 s
8720169588608	RC132V G6 40S/830 SIA W60L60 OC IA4	-10 tot +35 °C	Voor montage op normaal brandbare oppervlakken	Temperatuur 650 °C, duur 30 s	8720169588745	RC132V G6 36S/840 PSD W60L60 OC	0 °C t/m 35 °C	Voor montage op normaal brandbare oppervlakken	Temperatuur 850 °C, duur 30 s
8720169749894	RC132V G6 29_36_43S/ 830_40 PSDW30L120OC	-10 tot +35 °C	Voor montage op normaal brandbare oppervlakken	Temperatuur 650 °C, duur 30 s	8720169588752	RC132V G6 36S/840 WIA W60L60 OC	0 °C t/m 35 °C	Voor montage op normaal brandbare oppervlakken	Temperatuur 850 °C, duur 30 s
8720169751323	RC132V G6 40_43S/830_40 WIA 30x120 OC	-10 tot +35 °C	Voor montage op normaal brandbare oppervlakken	Temperatuur 650 °C, duur 30 s	8720169749818	RC132V G6 36S/ UE840 PSU W60L60 NOC	-10 tot +35 °C	Voor montage op normaal brandbare oppervlakken	Temperatuur 650 °C, duur 30 s
8720169588769	RC132V G6 36S/840 PSU W30L120 OC ELB3	0 °C t/m 35 °C	Voor montage op normaal brandbare oppervlakken	Temperatuur 850 °C, duur 30 s	8720169749825	RC132V G6 36S/ UE840 PSU W60L60 OC	-10 tot +35 °C	Voor montage op normaal brandbare oppervlakken	Temperatuur 650 °C, duur 30 s
8720169750067	RC132V G6 36S/840 WIA W30L120 OC	-10 tot +35 °C	Voor montage op normaal brandbare oppervlakken	Temperatuur 650 °C, duur 30 s	8720169749832	RC132V G6 36S/ UE840 PSD W60L60 OC	-10 tot +35 °C	Voor montage op normaal brandbare oppervlakken	Temperatuur 650 °C, duur 30 s
8720169735118	RC132V G6 36S/840 PSU W30L120 NOC	-10 tot +35 °C	Voor montage op normaal brandbare oppervlakken	Temperatuur 650 °C, duur 30 s	8720169749849	RC132V G6 50S/840 PSD W60L60 OC	-10 tot +35 °C	Voor montage op normaal brandbare oppervlakken	Temperatuur 650 °C, duur 30 s
8720169735149	RC132V G6 36S/840 PSU W30L120 OC	-10 tot +35 °C	Voor montage op normaal brandbare oppervlakken	Temperatuur 650 °C, duur 30 s	8720169749993	RC132V G6 34S/830 WIA W60L60 OC	-10 tot +35 °C	Voor montage op normaal brandbare oppervlakken	Temperatuur 650 °C, duur 30 s
8720169735170	RC132V G6 36S/840 PSD W30L120 OC	-10 tot +35 °C	Voor montage op normaal brandbare oppervlakken	Temperatuur 650 °C, duur 30 s	8720169750005	RC132V G6 36S/840 WIA W60L60 OC	-10 tot +35 °C	Voor montage op normaal brandbare oppervlakken	Temperatuur 650 °C, duur 30 s
8720169735620	RC132V G6 48S/940 PSD W60L60 OC IP65	-10 tot +35 °C	Voor montage op normaal brandbare oppervlakken	Temperatuur 650 °C, duur 30 s	8720169750029	RC132V G6 43S/840 WIA W60L60 OC	-10 tot +35 °C	Voor montage op normaal brandbare oppervlakken	Temperatuur 650 °C, duur 30 s

CoreLine Paneel gen6

Order Code	Full Product Name	Bereik omgevingstemperatuur	Brandbaarheidsmarkering	Gloeidraad	Order Code	Full Product Name	Bereik omgevingstemperatuur	Brandbaarheidsmarkering	Gloeidraad
8720169751309	RC132V G6 36S/UE840 WIA W60L60 OC	-10 tot +35 °C	Voor montage op normaal brandbare oppervlakken	Temperatuur 650 °C, duur 30 s	8720169835238	RC132V G6 43S/840 SIA W30L120 OC	0 °C t/m 35 °C	-	Temperatuur 650 °C, duur 30 s
8720169751330	RC132V G6 34S/830 PSU W60L60 NOC	-10 tot +35 °C	Voor montage op normaal brandbare oppervlakken	Temperatuur 650 °C, duur 30 s	8720169749900	RC132V G6 29_36_43S/830_40 PSU W60L60NOC	-10 tot +35 °C	Voor montage op normaal brandbare oppervlakken	Temperatuur 650 °C, duur 30 s
8720169751347	RC132V G6 34S/830 PSU W60L60 OC	-10 tot +35 °C	Voor montage op normaal brandbare oppervlakken	Temperatuur 650 °C, duur 30 s	8720169751316	RC132V G6 40_43S/830_40 WIA 60x60 OC	-10 tot +35 °C	Voor montage op normaal brandbare oppervlakken	Temperatuur 650 °C, duur 30 s
8720169735095	RC132V G6 36S/840 PSU W60L60 NOC	-10 tot +35 °C	Voor montage op normaal brandbare oppervlakken	Temperatuur 650 °C, duur 30 s	8720169735187	RC132V G6 29_36_43S/830_40 PSU W60L60 OC	-10 tot +35 °C	Voor montage op normaal brandbare oppervlakken	Temperatuur 650 °C, duur 30 s
8720169735125	RC132V G6 36S/840 PSU W60L60 OC	-10 tot +35 °C	Voor montage op normaal brandbare oppervlakken	Temperatuur 650 °C, duur 30 s	8720169735194	RC132V G6 29_36_43S/830_40 PSD W60L60 OC	-10 tot +35 °C	Voor montage op normaal brandbare oppervlakken	Temperatuur 650 °C, duur 30 s
8720169735156	RC132V G6 36S/840 PSD W60L60 OC	-10 tot +35 °C	Voor montage op normaal brandbare oppervlakken	Temperatuur 650 °C, duur 30 s					
8720169749955	RC132V G6 31_36_43S/940 PSD W60L60 OC	-10 tot +35 °C	Voor montage op normaal brandbare oppervlakken	Temperatuur 650 °C, duur 30 s					

Initiële prestaties (conform IEC)

Order Code	Full Product Name	Aanvankelijke kleurkwaliteit	Order Code	Full Product Name	Aanvankelijke kleurkwaliteit
8720169588592	RC132V G6 43S/840 SIA W60L60 OC IA4	(0.38, 0.38) SDCM ≤3	8720169749832	RC132V G6 36S/UE840 PSD W60L60 OC	(0.38, 0.38) SDCM ≤3
8720169588608	RC132V G6 40S/830 SIA W60L60 OC IA4	(0.38, 0.38) SDCM ≤3	8720169749849	RC132V G6 50S/840 PSD W60L60 OC	(0.38, 0.38) SDCM ≤3
8720169749894	RC132V G6 29_36_43S/830_40 PSDW30L120OC	(0.38, 0.38) SDCM ≤3	8720169749993	RC132V G6 34S/830 WIA W60L60 OC	(0.43, 0.40) SDCM ≤3
8720169751323	RC132V G6 40_43S/830_40 WIA 30x120 OC	(0.38, 0.38) SDCM ≤3	8720169750005	RC132V G6 36S/840 WIA W60L60 OC	(0.38, 0.38) SDCM ≤3
8720169588769	RC132V G6 36S/840 PSU W30L120 OC ELB3	(0.38, 0.38) SDCM ≤3	8720169750029	RC132V G6 43S/840 WIA W60L60 OC	(0.38, 0.38) SDCM ≤3
8720169750067	RC132V G6 36S/840 WIA W30L120 OC	(0.38, 0.38) SDCM ≤3	8720169751309	RC132V G6 36S/UE840 WIA W60L60 OC	(0.38, 0.38) SDCM ≤3
8720169735118	RC132V G6 36S/840 PSU W30L120 NOC	(0.38, 0.38) SDCM ≤3	8720169751330	RC132V G6 34S/830 PSU W60L60 NOC	(0.43, 0.40) SDCM ≤3
8720169735149	RC132V G6 36S/840 PSU W30L120 OC	(0.38, 0.38) SDCM ≤3	8720169751347	RC132V G6 34S/830 PSU W60L60 OC	(0.43, 0.40) SDCM ≤3
8720169735170	RC132V G6 36S/840 PSD W30L120 OC	(0.38, 0.38) SDCM ≤3	8720169735095	RC132V G6 36S/840 PSU W60L60 NOC	(0.38, 0.38) SDCM ≤3
8720169735620	RC132V G6 48S/940 PSD W60L60 OC IP65	(0.38, 0.38) SDCM ≤3	8720169735125	RC132V G6 36S/840 PSU W60L60 OC	(0.38, 0.38) SDCM ≤3
8720169588738	RC132V G6 36S/840 PSU W60L60 OC ELB3	(0.38, 0.38) SDCM ≤3	8720169735156	RC132V G6 36S/840 PSD W60L60 OC	(0.38, 0.38) SDCM ≤3
8720169588745	RC132V G6 36S/840 PSD W60L60 OC ELB3	(0.38, 0.38) SDCM ≤3	8720169749955	RC132V G6 31_36_43S/940 PSD W60L60 OC	(0.38, 0.38) SDCM ≤3
8720169588752	RC132V G6 36S/840 WIA W60L60 OC ELB3	(0.38, 0.38) SDCM ≤3	8720169835238	RC132V G6 43S/840 SIA W30L120 OC IA4	(0.38, 0.38) SDCM ≤3
8720169749818	RC132V G6 36S/UE840 PSU W60L60 NOC	(0.38, 0.38) SDCM ≤3	8720169749900	RC132V G6 29_36_43S/830_40 PSU W60L60NOC	(0.38, 0.38) SDCM ≤3
8720169749825	RC132V G6 36S/UE840 PSU W60L60 OC	(0.38, 0.38) SDCM ≤3	8720169751316	RC132V G6 40_43S/830_40 WIA 60x60 OC	(0.38, 0.38) SDCM ≤3
			8720169735187	RC132V G6 29_36_43S/830_40 PSU W60L60 OC	(0.38, 0.38) SDCM ≤3
			8720169735194	RC132V G6 29_36_43S/830_40 PSD W60L60 OC	(0.38, 0.38) SDCM ≤3

CoreLine Paneel gen6

Polar Wide Diagrams

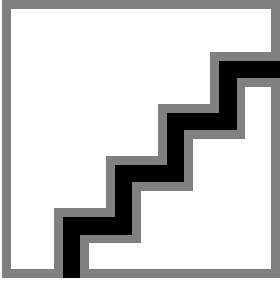

Polar Normal (separate) - RC132VI -
910505102803

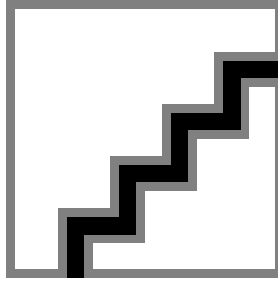

Polar Normal (separate) - RC132VI -
910505102818

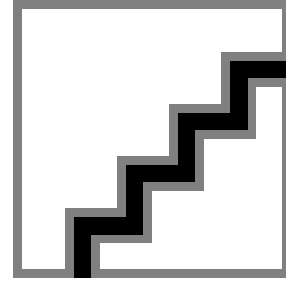

Polar Normal (separate) - RC132VI -
910505102817

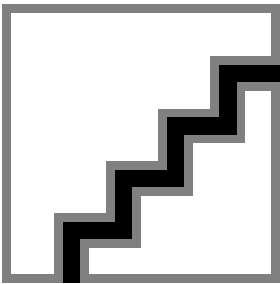

Polar Normal (separate) - RC132VI -
910505102819

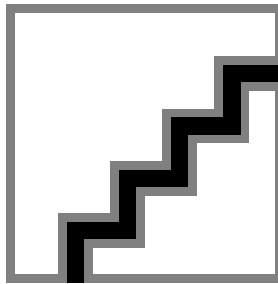

Polar Normal (separate) - RC132VI -
910505102802

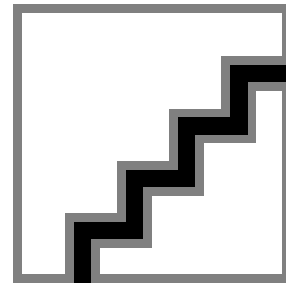

Polar Normal (separate) - RC132VI -
910505102816

