

PHILIPS

Maxos fusion

LL550E MPS Gen2

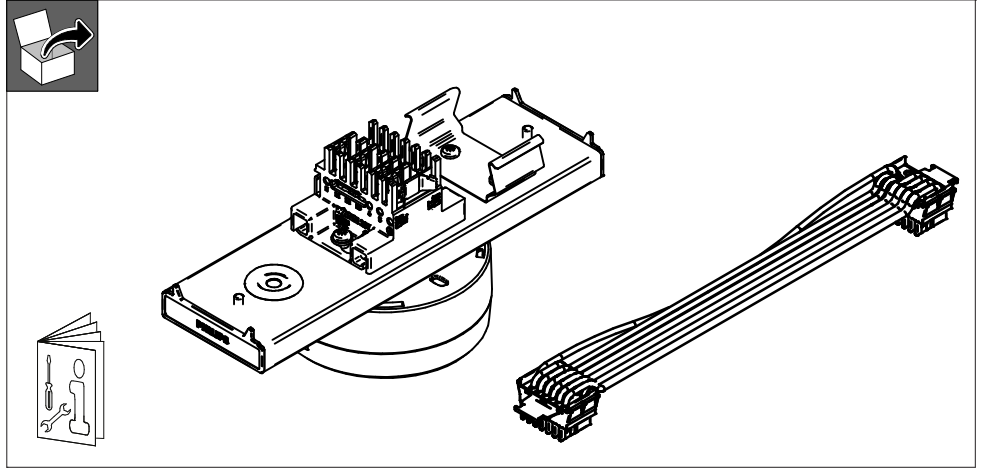

LL550E MPM Gen2
LL550E MPL Gen2
LL550E MPH Gen 2

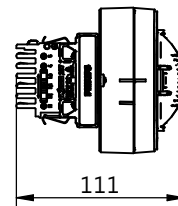
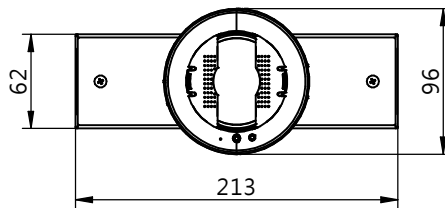

Model	PE	N	L1	L2	L3	4	5	6	7	8	9	10	11	LL...T7	LL...T9	LL...T13
LL550E MPS Gen2	PE	N	L1			DA-	DA+							✓	✓	✓

IMPORTANT INFORMATION - READ BEFORE INSTALLATION

- for use with panels with PSD, DIA drivers.
- **use trunk to trunk connector delivered with the sensor unit to separate DALI lines between two trunks to separate a group of 1 sensor + max. 10 drivers from another group along the light line**
- use max. 10 panels per one DALI line segment
- do not connect more than one sensor unit to one DALI line segment
- do not connect more than one emergency light unit to one DALI line segment
- do not connect any external power sources to DALI
- max 25 m distance (line-of-sight) between sensor unit

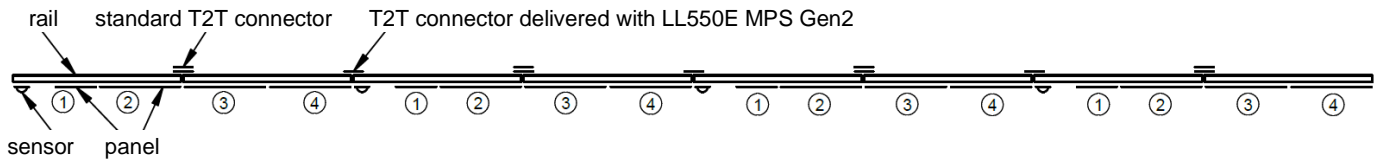
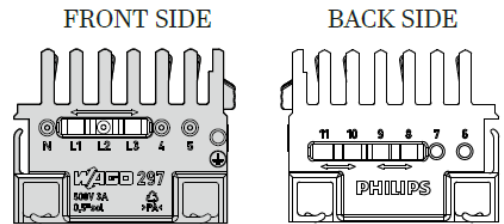

Installation of the delivered T2T connector to separate DALI lines

1. Take the T2T connector delivered with LL550E MPS Gen2 out of the box
2. Remove preinstalled standard T2T connector
3. Install T2T connector delivered with LL550E MPS Gen2

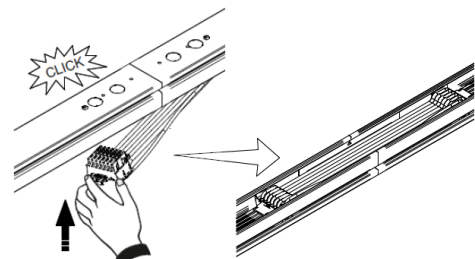
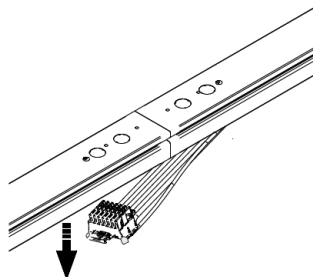
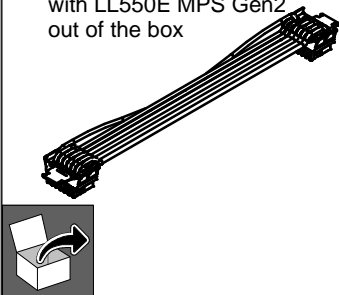

LL550E MPS Gen2 Box



583 - 442710539420

2026-04-03
© Signify Holding
All rights reserved

Installation

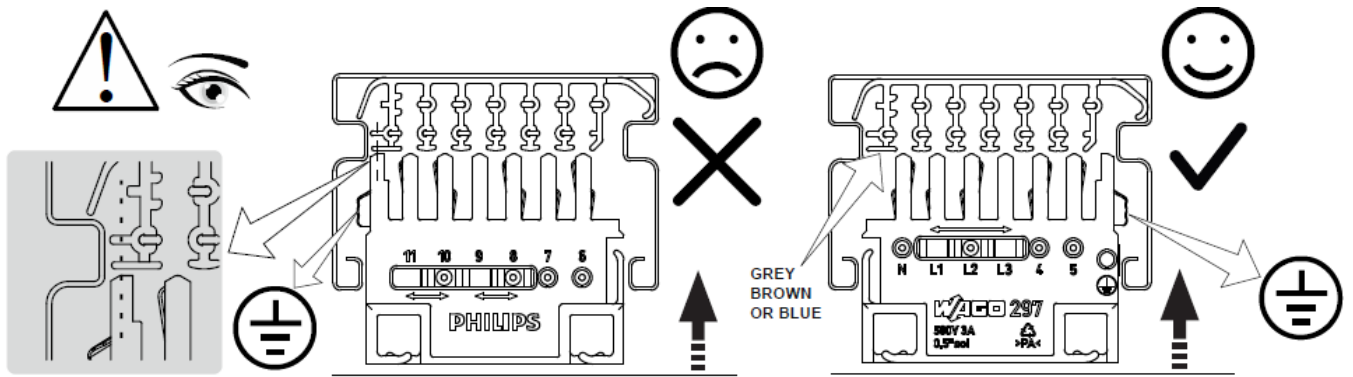
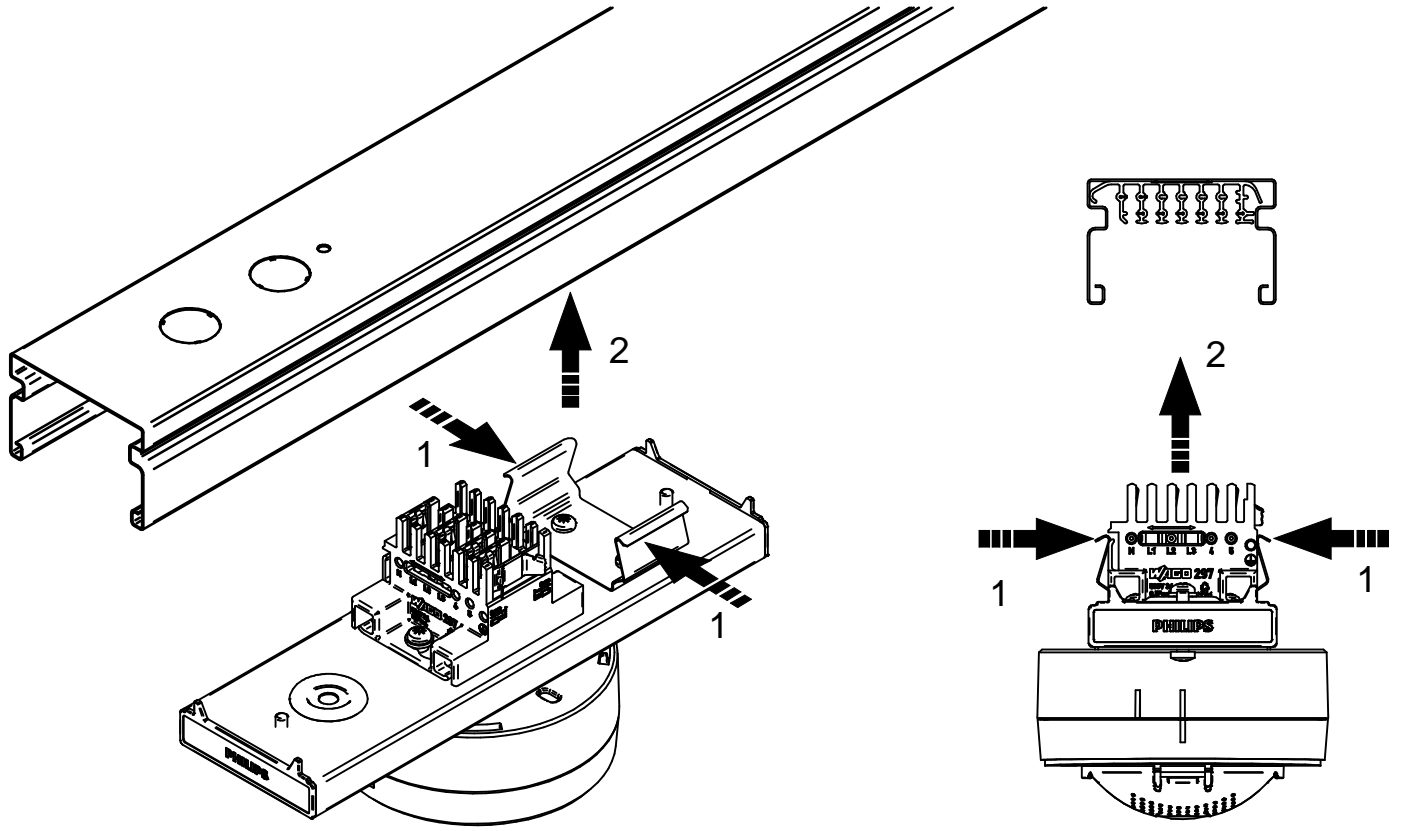

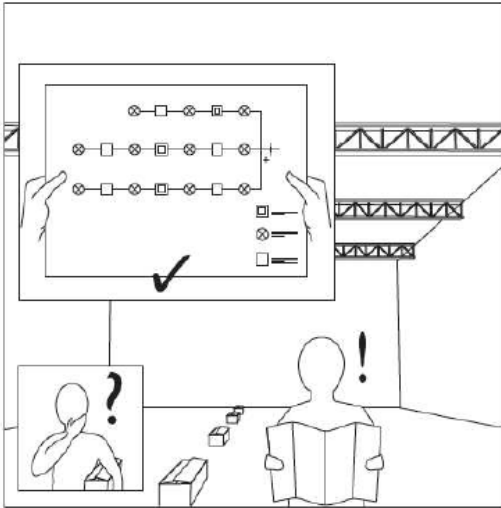

You must have a lighting plan, if you install the warehouse system.

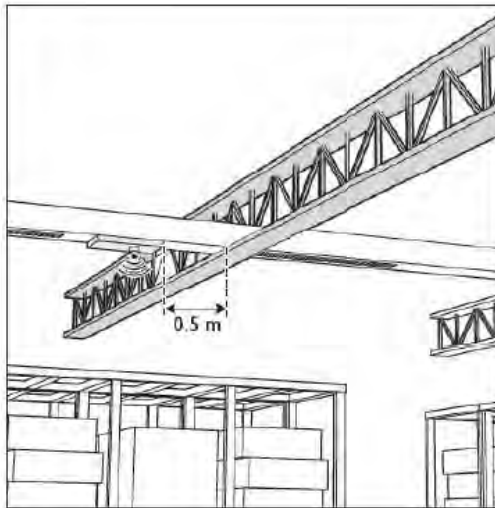

Do not install the warehouse system control unit close to steel or concrete constructions.

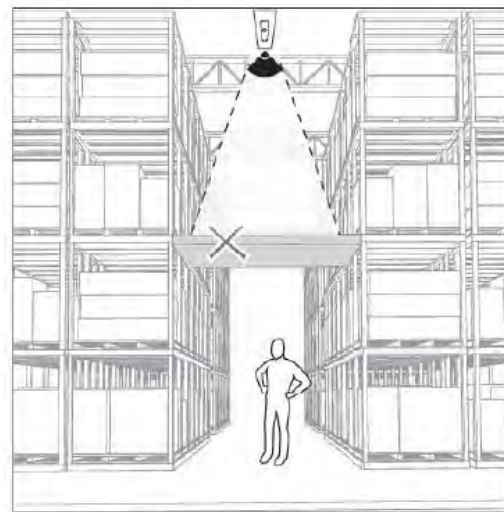
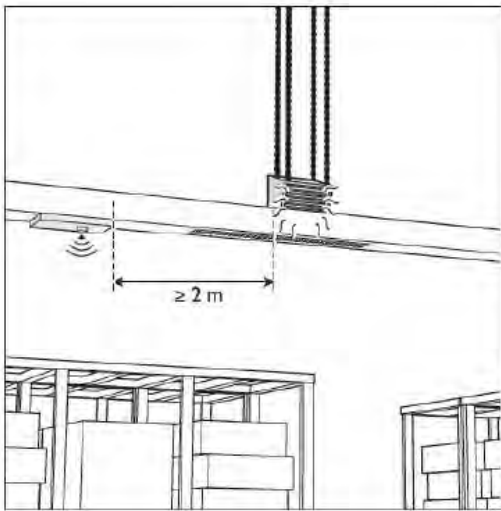

Do not block the view of the warehouse system sensor.



© 2026 Signify Holding

All rights reserved. This document contains information relating to the product portfolio of Signify which information may be subject to change. No representation or warranty as to the accuracy or completeness of the information included herein is given and any liability for any action in reliance thereon is disclaimed. The information presented in this document is not intended as any commercial offer and does not form part of any quotation or contract. Philips and the Philips Shield Emblem are registered trademarks of Koninklijke Philips N.V.. All other trademarks are owned by Signify Holding or their respective owners.

Signify Holding
The Netherlands