

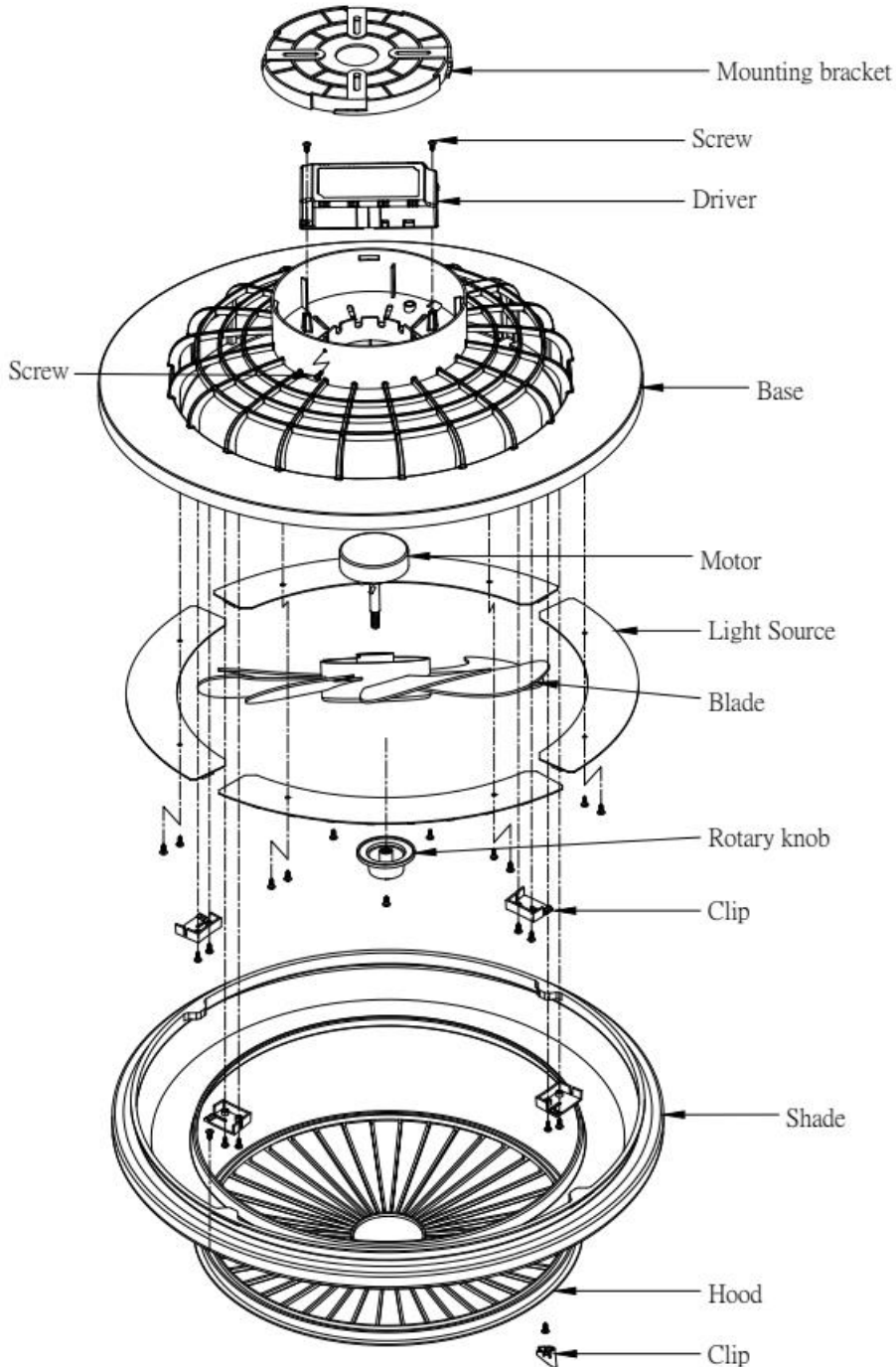











Removability Introduction on Disposal at End of Life

Composition Explanation – Flat Fan Ceiling



Removability Introduction on Disposal at End of Life

Composition Explanation – Flat Fan Ceiling

Plastic part	Electrical part	Metal part
Base 	Light Source 	Screw 
Shade 	Driver 	
Blade 	Motor 	
Hood 		
Rotary knob 		
Mounting bracket 		
Clip 		

C Recommendation on disposal

- Plastic part :reuse and recycling
- Electrical part :incineration and disposal
- Metal part :recycling

Removability Introduction on Disposal at End of Life

Composition Explanation – Flat Fan Ceiling

