

Project		Catalog #		Type	
Prepared by		Notes		Date	



Metalux

OHBL

LED High Bay Efficiency Luminaire
4 ft. Length

Typical Applications

Industrial • Commercial • Manufacturing • Food Processing • Sports / Multi-Purpose

Interactive Menu

- Order Information [page 2](#)
- Photometric Data [page 4](#)
- Control Solutions [page 8](#)
- Product Warranty

Product Certification



Product Features



Top Product Features

- Precision designed optical performance
- Offered in both standard and high efficacy versions
- High performance efficacy up to 200 lm/W
- Efficient 1-for-1 replacement of linear fluorescent & HID fixtures
- Lumen packages – 9K, 12K, 15K, 18K, 24K, 30K, 36K, 48K, 60K, 72K, 90K, 100K
- Narrow, medium, and wide distribution
- Options to meet Build America, Buy America, Buy American and other domestic preference requirements

Dimensional and Mounting Details

OHBL-9HE, 12SE, 15SE, 18HE, 18SE, 24SE, 30SE, 36SE

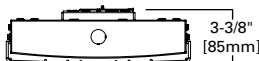
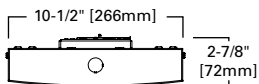

OHBL-24HE, 30HE, 36HE, 48SE, 60SE

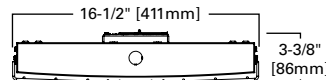
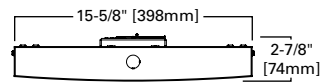

OHBL-48HE, 60HE, 72SE, 90SE, 100SE

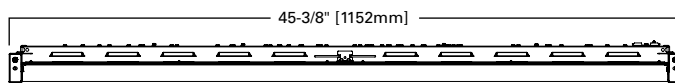
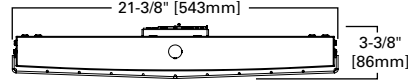
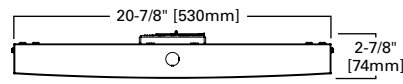

[additional product diagrams](#)

Order Information

SAMPLE ORDER NUMBER: **OHBL-24SE-MFL-UNV-L840-CD-WLS4-U** Includes V Hangers for rapid installation

Domestic Preferences ⁽¹⁾	Series ^{(1),(2)}	Lumen Package	Efficacy	Distribution/Shielding	Voltage ^{(6),(7),(8)}	CCT/CRI
[Blank] =Standard BAA =Buy American Act TAA =Trade Agreements Act BABAF =FHWA and FTA projects funded through October 1, 2026	OHBL =Optimized High Bay, 4 ft.	9 =9,000 Lumens 12 =12,000 Lumens 15 =15,000 Lumens 18 =18,000 Lumens 24 =24,000 Lumens 30 =30,000 Lumens 36 =36,000 Lumens 48 =48,000 Lumens 60 =60,000 Lumens ⁽³⁾ 72 =72,000 Lumens ⁽³⁾ 90 =90,000 lumens ⁽³⁾ 100 =100,000 lumens ⁽³⁾	SE =Standard Efficacy ⁽⁴⁾ HE =High Efficacy ⁽⁵⁾	A =Aisle N =Narrow MFL =Medium Frosted MCL =Medium Clear W =Wide	120V =120 Volt 277V =277 Volt 347V =347 Volt 480V =480 Volt UNV =Universal Voltage 120-277 UNC =Universal Voltage 347/480	L730 =70CRI / 3000K L735 =70CRI / 3500K L740 =70CRI / 4000K L750 =70CRI / 5000K L830 =80CRI / 3000K L835 =80CRI / 3500K L840 =80CRI / 4000K L850 =80CRI / 5000K L930 =90CRI / 3000K L935 =90CRI / 3500K L940 =90CRI / 4000K L950 =90CRI / 5000K
Notes (1) Only product configurations with these prefixes are built to be compliant with the Buy American Act of 1933 (BAA), Trade Agreements Act of 1979 (TAA), or the Build America Buy America Act (BABA). BABA is the minimum Government compliance requirement for the Build America Buy America standards which is part of the Infrastructure and Investment Jobs Act (IIJA). Individual Government Agencies may have more stringent compliance standards. BABAF designates the product will meet the standards set for FHWA and FTA. As noted, these must be funded by October 1, 2026. Please refer to DOMESTIC.PREFERENCES website or consult the CLS Domestic Preferences team for more information. Components shipped separately may be separately analyzed under domestic preference requirements.	Notes (2) DesignLights Consortium® Qualified and classified for both DLC Standard and DLC Premium, refer to www.designlights.org for details.	Notes (3) 60HE, 72SE, 90SE, and 100SE configuration not available with the combination of sensors or EBP plus 347V, 480V, or UNC.	Notes (4) SE not available in 9 lumen packages. (5) HE not available in 12K, 15K, 72K, 90K, and 100K.		Notes (6) Voltage must be specified when ordered with plugs or emergency drivers. (7) When ordering sensor or EBP/TD option, specify as UNV (for 120V or 277V), 347V or 480V. (8) Ambient temperatures limited to 40C when using emergency, sensors, or 5LTD in conjunction with 347V or 480V.	

Options	Driver Type	Wiring	Options / Integrated Sensor
UPL__ =Uplight (Select lumens from 12, 15, 18, 24, 30, 36) Refer to compatibility chart below ⁽¹⁵⁾ Emergency * EL20W =20-watt 120V-277V emergency battery pack installed ^{(9),(10),(12),(13),(14)} EL20-W-REM =20-watt 120V-277V emergency battery pack remote mounted ^{(9),(10),(13),(14)} ETRD =120-277V Emergency Transfer Relay with dimming control ^{(11),(12),(27)} WNPS =WaveLinX wireless Normal Power Sensing (NPS) capable device ⁽²⁷⁾	CD =Standard Dimming Driver ⁽¹⁸⁾ 5LTD =DALI Driver ^{(16),(17)}	C3 (1) =1 Circuit, 3' Cord with no Plug C3 (2) =2 Circuits, 3' Cord with no Plug C6 (1) =1 Circuit, 6' Cord with no Plug C6 (2) =2 Circuits, 6' Cord with no Plug C10 (1) =1 Circuit, 10' Cord with no Plug C10 (2) =2 Circuits, 10' Cord with no Plug PC3/120 =(NEMA L5-15P) 3' Cord with NEMA Plug PC3/277 =(NEMA L7-15P) 3' Cord with NEMA Plug PC3/347 =(NEMA L24-20P) 3' Cord with NEMA Plug PC3/480 =(NEMA L8-20P) 3' Cord with NEMA Plug PC6/120 =(NEMA L5-15P) 6' Cord with NEMA Plug PC6/277 =(NEMA L7-15P) 6' Cord with NEMA Plug PC6/347 =(NEMA L24-20P) 6' Cord with NEMA Plug PC6/480 =(NEMA L8-20P) 6' Cord with NEMA Plug	MP =Modular Plug ⁽²⁰⁾ PAF =Painted After Fabrication HA =High Ambient ⁽²¹⁾ IP5X =Optics IP5X rated Motion Sensors MS =360° or 180° Motion Sensor Installed, (specify voltage) ⁽¹⁹⁾ OEPF010VMV =Occupancy Sensor with Integrated Photocell ⁽¹⁹⁾ FSP-211/L7 =PIR Occupancy Sensor with integral 0-10V Dimming ^{(20),(23)} FSP-321/L7 =PIR Occupancy Sensor with Integral 0-10V dimming ^{(19),(23)} ZLD1Z =Leviton 120-277V PIR Occupancy Sensor with integral 0-10V Dimming ⁽²²⁾ WLS2 =WaveLinX LITE Wireless Sensor, 7' - 15' Mounting Height ⁽¹⁹⁾ WPS2 =WaveLinX PRO Wireless Sensor, 7' - 15' Mounting Height ⁽¹⁹⁾ WLS4 =WaveLinX LITE, Dimming Motion and Daylight, Bluetooth Programmable, 15' - 40' Mounting ⁽¹⁹⁾ WPS4 =WaveLinX PRO, Dimming Motion and Daylight, WAC Programmable, 15' - 40' Mounting ⁽¹⁹⁾ ZLDUZ =Leviton 347-480V PIR Occupancy Sensor with integral 0-10V Dimming ^{(19),(23)}
Notes * Emergency and transfer devices are UL924 listed. (9) For approximate delivered lumens multiply the lumens per watt of the desired fixture by the wattage of the emergency battery pack. (10) EM options available in 0°C - 45°C ambient. (11) Used to transfer fixture to secondary power during outage. Must be used in conjunction with UL 1008 device (provided by others). ETRD option only requires one relay when used on a dimming fixture. A maximum of two devices can be used on one product. (12) OHB-SPM mounting not available with EL20W or ETRD options. (13) Refer to Ambient Chart for temperature ratings. (14) Ambient temperatures limited to 40C when using emergency, sensors, or 5LTD in conjunction with 347V or 480V. (15) Uplight not available in 70CRI, 480v or UNC, 9HE, 72SE, 90SE or 100SE. Not available when using ETRD combined with 36K, 48K, and 60K lumens. *Ambient temp limited to 40C. (27) When using ETRD with fixtures 60K Lumens and above, the fixture will not deliver full lumen output when in emergency mode (consult factory). (27) Must be ordered with WLSx or WPSx sensor. WNPS cannot be ordered with emergency or relay options such as ETRD, GTR2, ELxxx or GTDU.	Notes (16) Sensor or UNC not available in conjunction with 5LTD driver. (17) UPL12 not available in conjunction with 5LTD. (18) Standard dimming driver is 0-10V unless utilizing integrated controls.		Notes (19) When ordering sensor or EBP/TD option, specify as UNV (for 120V or 277V), 347V or 480V. (20) Requires use of MC or MPC cord accessories, specify voltage for plugs (MP). (21) High Ambient not available with integrated emergency. (22) Available for UNV (for 120V or 277V) only. (23) Available for UNC (for 347V or 480V) only.

Packaging	Accessories (order separately) ⁽²⁶⁾
U =Unit Pack PALC =Job Pack, in carton	OHBL-WG114 =Wire guard for 9HE, 12SE, 15SE, 18HE, 18SE, 24SE, 30SE, and 36SE OHBL-WG164 =Wire guard for 24HE, 30HE, 36HE, 48SE, and 60SE OHBL-WG224 =Wire guard for 48HE, 60HE, 72SE, 90SE and 100SE Y-TOGGLE-__-2PK =(2) Y-Toggle Cable Kits (Specify 10 or 30 for length in feet) FH-1 =Fixture Hook ⁽²⁵⁾ FL-1 =Fixture Loop ⁽²⁵⁾ OHB-SPM =Single Point Mounting Hub ⁽²⁴⁾ MPC3 =3' Modular Power Cord & Plug (Specify Voltage) MPC6 =6' Modular Power Cord & Plug (Specify Voltage) MC3 =3' Modular Power Cord MC6 =6' Modular Power Cord
	Notes (24) Single Point Mount not available with integrated emergency. (25) Must be used in conjunction with OHB-SPM accessory for proper installation. (26) Accessories sold separately will be separately analyzed under domestic preference requirements. Consult factory for further information.

	Downlight Lumens	SE & HE	Uplight Lumens					
			UPL12	UPL15	UPL18	UPL24	UPL30	UPL36
			1200	1500	1800	2400	3000	3600
	Wattage		8.5	11	13.6	19	23	28
OHBL	12	12,000	X		X			
	15	15,000		X		X		
	18	18,000	X		X	X		
	24	24,000	X			X		X
	30	30,000		X			X	
	36	36,000			X			X
	48	48,000				X		
	60	60,000					X	

Notes: Uplight not available in 70 CRI

Product Specifications

Construction

- Rugged and durable scalable design with rigid, steel center channel
- Mechanically attached end caps provide strength and durability
- Suspension mounting with optional wire hook and chain set or cable; Single monopoint mounting with SPM tong hanger

Electrical

- Long-Life LED system coupled with electrical driver for optimal performance
- LED's available in 3000K, 3500K, 4000K and 5000K with 70 CRI, 80 CRI and 90 CRI options
- Electronic drivers are available for 120-277V, 347V and 480V applications
- 0-10V dimming control (standard)
- Operating temperature of -40°C to 55°C (refer to chart)

Emergency Options

- 20-watt, 120-277V integral emergency battery pack available to meet critical life-safety lighting requirements
- 90-minute batteries provide constant power to the LED system, ensuring code-compliance
- Integral emergency transfer relay available for generator equipped power systems
- WNPS enables Normal Power Sensing (NPS) functionality, allowing detection of normal power availability as part of a WaveLinX EM solution
- NPS must be ordered with WaveLinX LITE or PRO sensor to enable wireless sensing EM solution
- Order standard product with compatible emergency control device (ESP-P) when pairing NPS enabled luminaires in any space
- NPS luminaires meet requirements

Optics

- Precision designed optics deliver even illumination
- Offered in narrow, medium and wide distributions

Shielding

- Standard lensing provides additional LED protection and optical control
- Optional wire guards available for more complex environments

Controls

- Integrated WaveLinX sensor options provide wireless individual fixture control and enable code compliance, increased energy savings, grouping of fixtures, and connection to WaveLinX control systems
- WaveLinX industrial sensors offer installation heights up to 40 feet (45ft major motion) and have coverage patterns up to 5000 square feet (see sensor specifications - field of view)

Finish

- White enamel finish preceded by a multistage cleaning cycle
- Iron phosphate coating with rust inhibitor protects against contaminants and oxidation

Compliance

- cULus listed for damp locations
- LED modules comply with IESNA LM-79 and LM-80 standards
- DesignLights Consortium® Qualified and classified for both DLC Standard and DLC Premium (refer to www.designlights.org for details)
- RoHS compliant

BABA Domestic Preference Compliance

- FHWA and FTA agencies are utilizing their BAA rules for BABA compliance. Cooper's products with a BAA designation are manufactured in the US and utilize a BAA COTS exemption rule for compliance. To verify a configured product with specific accessories and options meet BABA Domestic Preference Requirements; submit this catalog number to Cooper Lighting Quotation team for validation by our Engineering and Manufacturing teams. Please refer to the [DOMESTIC PREFERENCES](#) website or consult the CLS Domestic Preferences team for more information. Components shipped separately may be separately analyzed under domestic preference requirements.

Warranty

- Five year limited warranty standard.

Photometric Data

[View IES files](#)

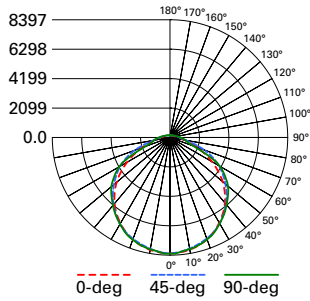

OHBL-24SE-MCL-UNV-L840-CD-U
 Electronic Driver
 Linear LED 4000K
 Spacing criterion: (II) 1.26 x mounting height, (⊥) 1.27 x mounting height
 Lumens: 23686
 Input Watts: 138W
 Efficacy: 171.6 LPW
 Test Report: OHB-24SE-MCL-UNV-L840-CD-U.IES

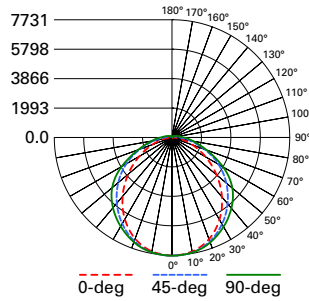

OHBL-24SE-MFL-UNV-L840-CD-U
 Electronic Driver
 Linear LED 4000K
 Spacing criterion: (II) 1.21 x mounting height, (⊥) 1.29 x mounting height
 Lumens: 23116
 Input Watts: 138W
 Efficacy: 167.5 LPW
 Test Report: OHB-24SE-MFL-UNV-L840-CD-U.IES

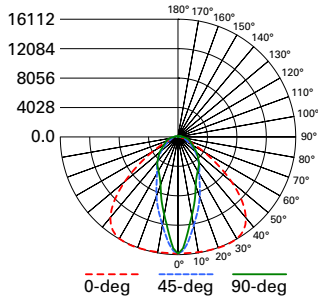

OHBL-24SE-N-UNV-L840-CD-U
 Electronic Driver
 Linear LED 4000K
 Spacing criterion: (II) 1.47 x mounting height, (⊥) 0.53 x mounting height
 Lumens: 23492
 Input Watts: 138W
 Efficacy: 170.2 LPW
 Test Report: OHB-24SE-N-UNV-L840-CD-U.IES

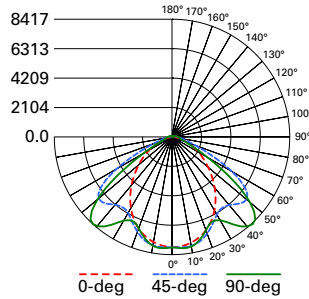

OHBL-24SE-W-UNV-L840-CD-U
 Electronic Driver
 Linear LED 4000K
 Spacing criterion: (II) 1.14 x mounting height, (⊥) 1.58 x mounting height
 Lumens: 23541
 Input Watts: 138W
 Efficacy: 170.6 LPW
 Test Report: OHB-24SE-W-UNV-L840-CD-U.IES

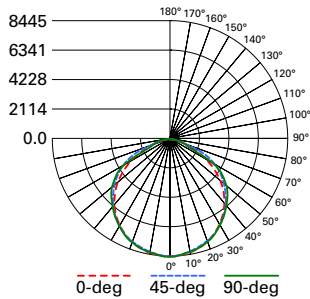

OHBL-24SE-A-UNV-L840-CD-U
 Electronic Driver
 Linear LED 4000K
 Spacing criterion: (II) 1.26 x mounting height, (⊥) 1.27 x mounting height
 Lumens: 23850
 Input Watts: 138W
 Efficacy: 172.8 LPW
 Test Report: OHBL-24SE-A-UNV-L840-CD-U.IES

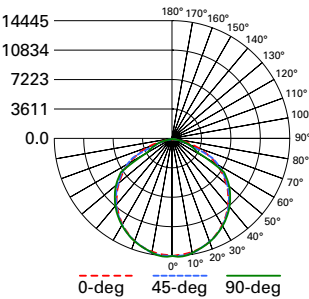

OHBL-24SE-NL-UNV-L840-CD-U
 Electronic Driver
 Linear LED 4000K
 Spacing criterion: (II) 1.26 x mounting height, (⊥) 1.28 x mounting height
 Lumens: 24707
 Input Watts: 138W
 Efficacy: 179 LPW
 Test Report: OHBL-24SE-NL-UNV-L840-CD-U.IES

Energy and Performance Data by Catalog Number

OHBL SE - 5000K 70CRI													
Catalog Number	Lumen Output						Watts	Efficacy (LPW)					
	A	N	MFL	MCL	W	NL	277V	A	N	MFL	MCL	W	NL
OHBL-12SE	12767	12576	12374	12680	12602	13226	70	182	180	177	181	180	189
OHBL-15SE	15766	15529	15281	15658	15562	16332	87	181	178	176	180	179	188
OHBL-18SE	18991	18706	18407	18861	18745	19673	105	181	178	175	180	179	187
OHBL-24SE	25109	24732	24336	24936	24783	26010	138	182	179	176	181	180	188
OHBL-30SE	31254	30785	30292	31039	30849	32376	174	180	177	174	178	177	186
OHBL-36SE	36151	35608	35038	35902	35682	37449	211	171	169	166	170	169	177
OHBL-48SE	51815	51037	50220	51458	51143	53675	289	179	177	174	178	177	186
OHBL-60SE	63370	62418	61420	62934	62548	65645	362	175	172	170	174	173	181
OHBL-72SE	75190	74061	72876	74673	74215	77890	414	182	179	176	180	179	188
OHBL-90SE	92955	91559	90094	92315	91750	96292	529	176	173	170	175	173	182
OHBL-100SE	100120	98617	97039	99431	98822	103715	590	170	167	164	168	167	176

OHBL SE - 5000K 80CRI													
Catalog Number	Lumen Output						Watts	Efficacy (LPW)					
	A	N	MFL	MCL	W	NL	277V	A	N	MFL	MCL	W	NL
OHBL-12SE	12162	11980	11788	12079	12005	12599	70	174	171	168	173	172	180
OHBL-15SE	15019	14794	14557	14916	14824	15558	87	173	170	167	171	170	179
OHBL-18SE	18092	17820	17535	17967	17857	18741	105	172	170	167	171	170	178
OHBL-24SE	23919	23560	23183	23755	23609	24778	138	173	171	168	172	171	180
OHBL-30SE	29773	29326	28857	29569	29387	30842	174	171	169	166	170	169	177
OHBL-36SE	34438	33921	33378	34201	33992	35675	211	163	161	158	162	161	169
OHBL-48SE	49360	48619	47841	49020	48720	51132	289	171	168	166	170	169	177
OHBL-60SE	60368	59461	58510	59952	59585	62535	362	167	164	162	166	165	173
OHBL-72SE	71628	70552	69423	71135	70699	74199	414	173	171	168	172	171	179
OHBL-90SE	88551	87221	85826	87941	87403	91730	529	167	165	162	166	165	173
OHBL-100SE	95377	93945	92442	94721	94140	98801	590	162	159	157	161	160	167

OHBL HE - 5000K 70CRI													
Catalog Number	Lumen Output						Watts	Efficacy (LPW)					
	A	N	MFL	MCL	W	NL	277V	A	N	MFL	MCL	W	NL
OHBL-9HE	9378	9237	9089	9314	9256	9715	52	180	178	175	179	178	187
OHBL-18HE	19182	18894	18592	19050	18933	19871	103	186	183	181	185	184	193
OHBL-24HE	25668	25282	24878	25491	25335	26589	133	193	190	187	192	190	200
OHBL-30HE	31524	31051	30554	31307	31115	32656	164	192	190	187	191	190	199
OHBL-36HE	37115	36558	35973	36860	36634	38448	212	175	172	170	174	173	181
OHBL-48HE	49265	48525	47749	48926	48626	51034	266	185	182	180	184	183	192
OHBL-60HE	61645	60719	59748	61221	60846	63858	338	182	180	177	181	180	189

OHBL HE - 5000K 80CRI													
Catalog Number	Lumen Output						Watts	Efficacy (LPW)					
	A	N	MFL	MCL	W	NL	277V	A	N	MFL	MCL	W	NL
OHBL-9HE	8934	8800	8659	8872	8818	9255	52	172	169	167	171	170	178
OHBL-18HE	18273	17999	17711	18147	18036	18929	103	177	175	172	176	175	184
OHBL-24HE	24452	24085	23699	24284	24135	25330	133	184	181	178	183	181	190
OHBL-30HE	30031	29580	29106	29824	29641	31109	164	183	181	178	182	181	190
OHBL-36HE	35357	34826	34269	35114	34898	36626	212	167	164	162	166	165	173
OHBL-48HE	46931	46226	45487	46608	46323	48616	266	176	174	171	175	174	183
OHBL-60HE	58725	57843	56917	58320	57963	60833	338	174	171	168	173	171	180

Optional Uplight will increase input wattages - refer to Uplight Chart for added wattage.

Energy and Performance Data by Catalog Number

Ambient Ratings

Lumen Package	Standard	(HA) High Ambient	EM
OHBL-9HE	65°C	-	45°C
OHBL-12SE	55°C	-	45°C
OHBL-15SE	45°C	55°C	45°C
OHBL-18SE	45°C	55°C	45°C
OHBL-18HE	55°C	-	45°C
OHBL-24SE	55°C	-	45°C
OHBL-24HE	55°C	-	45°C
OHBL-30SE	50°C	-	45°C
OHBL-30HE	55°C	-	45°C
OHBL-36SE	50°C	-	45°C
OHBL-36HE	55°C	-	45°C
OHBL-48SE	55°C	-	45°C
OHBL-48HE	55°C	-	45°C
OHBL-60SE	50°C	-	45°C
OHBL-60HE	55°C	-	45°C
OHBL-72SE	50C	-	-
OHBL-90SE	45C	-	-
OHBL-100SE	40C	-	-

Energy Data

Input Watts:
9HE (9,000 lumens)=52W
12SE (12,000 lumens)=70W
15SE (15,000 lumens)=87W
18SE (18,000 lumens)=105W
18HE (18,000 lumens)=103W
24SE (24,000 lumens)=138W
24HE (24,000 lumens)=130W
30SE (30,000 lumens)=174W
30HE (30,000 lumens)=164W
36SE (36,000 lumens)=211W
36HE (36,000 lumens)=212W
48SE (48,000 lumens)=289W
48HE (48,000 lumens)=266W
60SE (60,000 lumens)=362W
60HE (60,000 lumens)=338W
72SE (72,000 lumens)=414W
90SE (90,000 lumens)=529W
100SE (100,000 lumens)=590W

Shipping Data

Catalog No.	Wt.
OHBL-9HE	13 lbs.
OHBL-12SE	13 lbs.
OHBL-15SE	13 lbs.
OHBL-18SE	13 lbs.
OHBL-18HE	13 lbs.
OHBL-24SE	13 lbs.
OHBL-24HE	20 lbs.
OHBL-30SE	16 lbs.
OHBL-30HE	20 lbs.
OHBL-36SE	20 lbs.
OHBL-36HE	20 lbs.
OHBL-48SE	20 lbs.
OHBL-48HE	20 lbs.
OHBL-60SE	20 lbs.
OHBL-60HE	20 lbs.
OHBL-72SE	28 lbs.
OHBL-90SE	28 lbs.
OHBL-100SE	28 lbs.

Optional Uplight will increase input wattages - refer to Uplight Chart for added wattage.

Modular Power Supply Option

Modular Power Supply option is available for use with all F-Bay products. The modular power supply allows external fixture access for safe and easy servicing. There is no need to remove lamps or reflectors to disconnect fixture power with Modular Power Supply. Access to the individual fixture's power supply allows servicing without turning off all the fixtures, disrupting occupants. F-Bay Modular Power Supply is a time saver in installation - **simply plug & power.**



1. Modular Power Supply Receptacle supplied mounted into fixture Access Plate.
2. Modular Power Cord & Plugs in 120, 277, 347, & 480V configurations for easy plug & power into existing supply.

No internal fixture access required for installation or disconnecting power.

Lumen Maintenance

Ambient Temperature	TM-21 Lumen Maintenance (60,000 hours)	Theoretical L70 (Hours)
25°C	> 89%	> 182,000

Code Compliance

- UL/cUL Certified for Make/Break under load (UL2549)
- Meets NEC requirements for ballast disconnect (NEC 410.73G)
- Receptacle complete with insulating/dust cap

Dimensional and Mounting Details

OHBL-9HE, 12SE, 15SE, 18HE, 18SE, 24SE, 30SE, 36SE

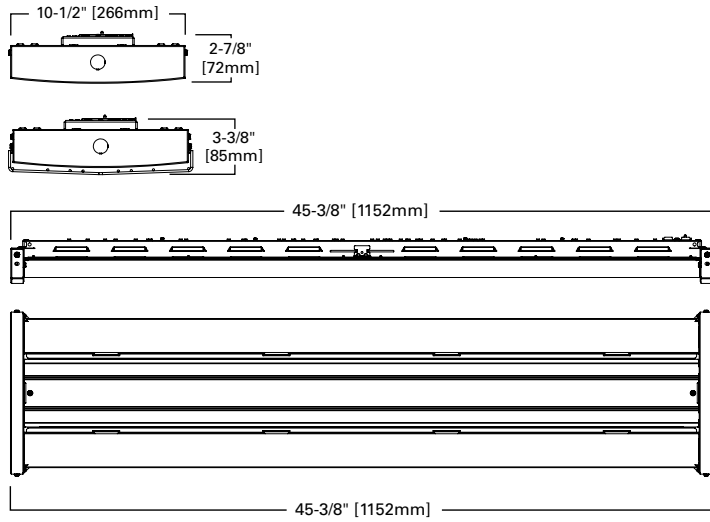

OHBL-24HE, 30HE, 36HE, 48SE, 60SE

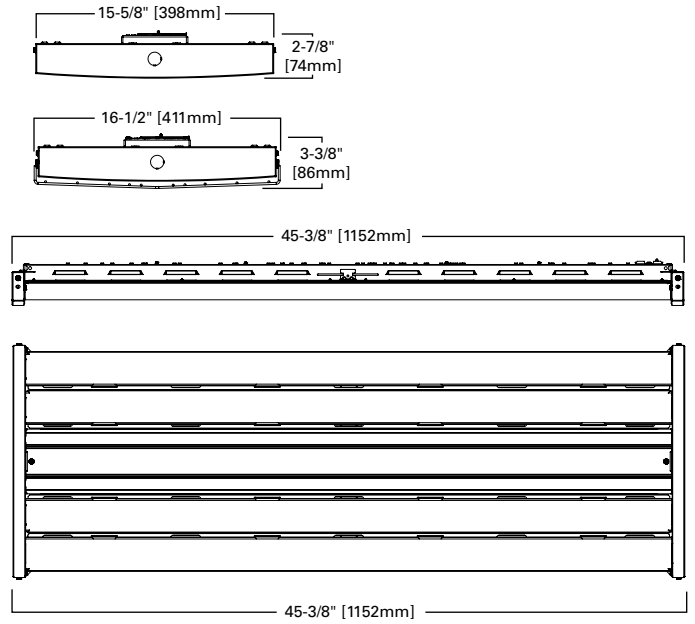

OHBL-48HE, 60HE, 72SE, 90SE, 100SE

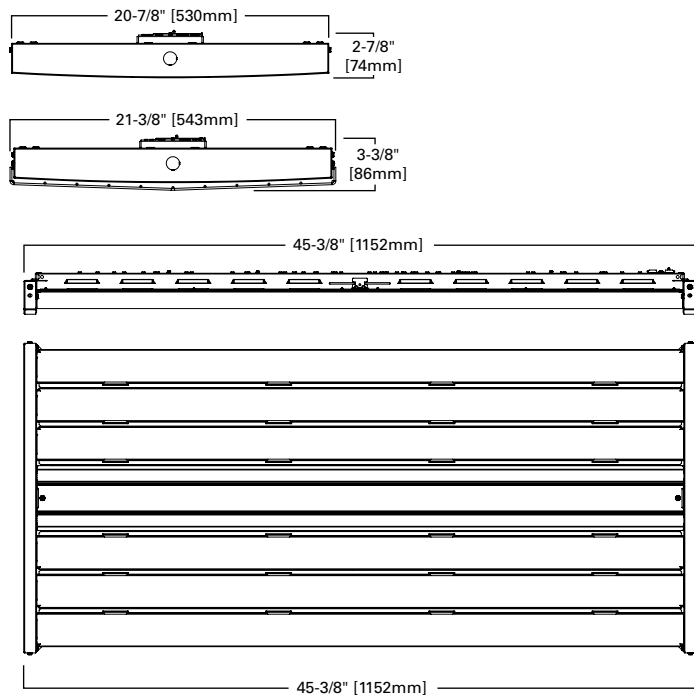

OHBL with EBP

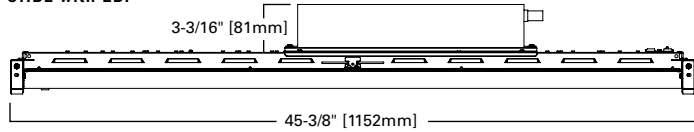

Control Solutions

- WaveLinX LITE wireless
- WaveLinX PRO wireless
- WaveLinX CAT wired
- WaveLinX Wired



The OHBL with WaveLinX offers no-hassle lighting control with multiple luminaire level control solutions.



WaveLinX PRO is a wireless lighting control solution, for connected spaces, that significantly reduces a building's energy consumption. From a single floor to an entire campus, WaveLinX PRO connects more than lighting assets; it shares aggregated sensor data with the WaveLinX CORE platform and other building systems, so building owners can improve operations, spaces environment, and tenants' experience. WaveLinX PRO offers a rich portfolio of wireless devices, WaveLinX PRO-enabled luminaires, and an intuitive WaveLinX mobile app for office, education, warehouse, and parking garage applications.



WaveLinX LITE is a cost effective, wireless digital lighting control solution, with out-of-the-box functionality, that saves energy and meets code. It's designed for applications that require occupancy-based, daylighting, or manual light control. Customize installations for office, education, warehouse and parking garages using the secure, simple mobile app.

Integrated Sensor Coverage Pattern

WaveLinX PRO/LITE Sensor – WLS2 and WPS2

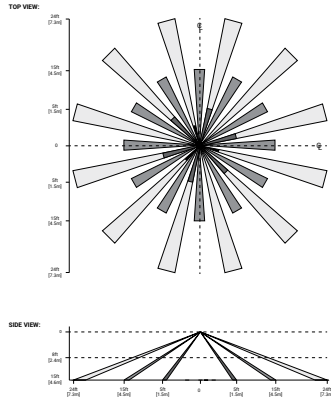

WaveLinX PRO/LITE Sensor – WLS4 and WPS4

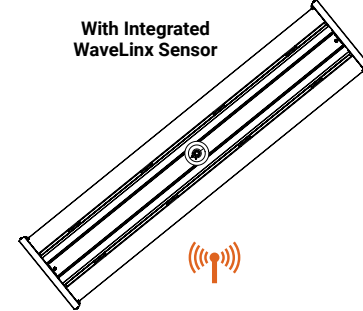
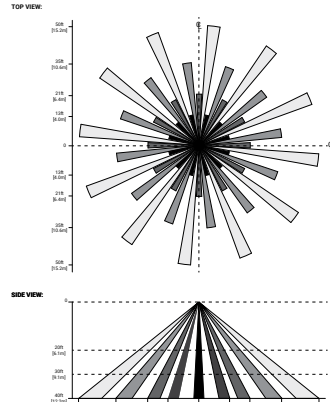

Integrated Controls Options					
Option	Out of the Box Functionality	Luminaire Level Lighting Control (LLLC)	Automatic Dimming Photocell	Occupancy Sensing	CCT Control
WLS	X	X	X	X	
WPS		X	X	X	

Note: The WNPS option is available with WLS or WPS sensors. Must be specified when ordered. Also note that WLS and WPS are also compatible with ESP-L-010-347 and ESP-P-010-347, respectively. Learn more about WaveLinX EM [here](#).

Systems comparison chart

Cooper Lighting Solutions provides many lighting system solutions designed to satisfy code requirements and meet the unique needs of any project.



Luminaire with standalone sensor



Standalone Spaces WaveLinX LITE



Standalone Spaces WaveLinX CAT



Networked Spaces WaveLinX PRO



Enterprise WaveLinX CORE

Occupancy	Yes	Yes	Yes	Yes	Yes
Daylighting	Yes	Yes	Yes	Yes	Yes
Wallstations	-	Yes	Yes	Yes	Yes
Gateways	-	-	-	1 WAC	300 WACs
Devices (MAX)	-	40 per Area (1120 per space)	40 per Area	200 per WAC2	32,500 per CORE Enterprise
Software	-	WaveLinX LITE Mobile App	WaveLinX CAT Mobile App	WaveLinX Mobile App	CORE
Areas	-	28 per Space	Unlimited	50 per WAC2	up to 3,000
Zones	-	16 per Area	16 per Area	16 per Area	up to 9,000
Scheduling	-	-	-	Local	Global
VividTune™	-	-	-	Yes	Yes
Plug-Load Control	-	Yes	Yes	Yes	Yes
Low-Voltage Power	-	-	Yes	Yes	Yes
Integration	-	-	-	-	BACnet, API
Dashboards	-	-	-	-	Energy, Occupancy
Configuration	-	Installer	Installer	Technician	Technician / IT