



Solusi LED terbaik untuk penggantian lampu Pelepasan Intensitas Tinggi (HID)

TrueForce Core LED Industri dan Retail (Highbay – HPI/SON/HPL)

Lampu Philips TrueForce Core LED I&R menawarkan solusi LED yang mudah dengan waktu payback singkat untuk mengganti lampu Pelepasan Intensitas Tinggi (HID). Produk ini menghadirkan efisiensi energi dan manfaat masa pakai LED yang panjang untuk penggantian HID serta hemat biaya dan memberikan investasi awal yang rendah. Dengan ukuran lampu dan distribusi cahaya yang tepat, retrofit dan pintasan lampu TrueForce Core LED I&R dapat dilakukan dengan mudah pada sistem yang ada tanpa mengubah ballast atau reflektor luminer, sekaligus meningkatkan kualitas pencahayaan.

Benefits

- Hemat biaya dengan waktu payback singkat
- Lampu di ruang kerja yang lebih luas
- Investasi awal rendah
- Peningkatan kualitas pencahayaan dengan penggunaan mudah

Features

- Efisiensi energi tinggi
- Masa pakai 20.000 jam
- Sudut cahaya lebar, 240°
- Ballast pintasan dan lebih hemat energi
- Cahaya putih yang nyaman dengan CRI 80

TrueForce Core LED Industri dan Retail (Highbay – HPI/SON/HPL)

Application

• Industri/retail – gudang, pabrik, pertokoan, pusat transportasi

Versions



LEDTForce Core HB Tshape E27



LEDTForce Core HB Tshape E40 1



LEDTForce Core Tshape E27 FR 2



LEDTForce Core Tshape E27 FR 3



LEDTForce Core Tshape E27 FR 1

Dimensional drawing

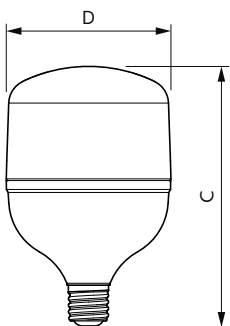

Product	D	C
TForce Core HB 80W E40 865 GN3	160 mm	269 mm
TForce Core HB MV ND 65W E40 840 G3	160 mm	269 mm

TrueForce Core LED Industri dan Retail (Highbay – HPI/SON/HPL)

Dimensional drawing

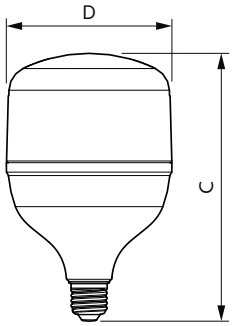

Product	D	C
TForce Core HB 40W E27 865 GN3	118 mm	193 mm
TForce Core HB MV ND 35W E27 840 G3	118 mm	193 mm

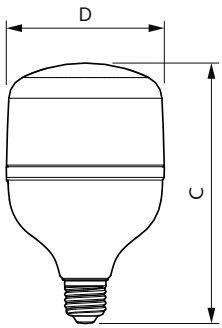

Product	D	C
TForce Core HB 30W E27 865 GN3	100 mm	165 mm

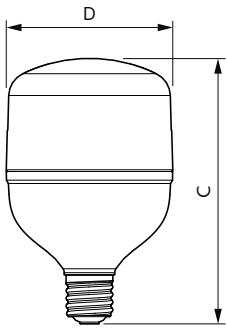

Product	D	C
TForce Core HB 50W E40 865 GN3	139 mm	224 mm
TForce Core HB 65W E40 865 GN3	140 mm	224 mm

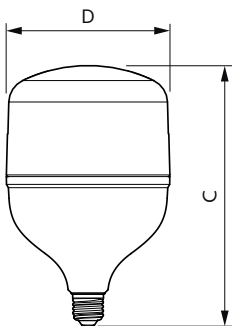

Product	D	C
TForce Core HB 50W E27 865 GN3	139 mm	221 mm

TrueForce Core LED Industri dan Retail (Highbay – HPI/SON/HPL)

Dimensional drawing

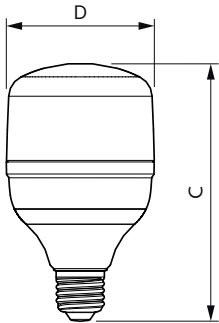

Product	D	C
TForce Core HB 25W E27 865 GN3	80 mm	139 mm

Informasi Umum	
Siklus Sakelar	50.000
Teknis Lampu	
Sudut Cahaya (Nom)	180 °
Indeks renderasi warna (CRI)	80
LLMF di Akhir Masa Pakai Nominal (Nom)	70 %
Pengoperasian dan Kelistrikan	
Frekuensi Input	50 hingga 60 Hz
Frekuensi Garis	50 to 60 Hz
Waktu Mulai (Nom)	0,5 s
Suhu	
Kisaran suhu ambien	-20 °C hingga 45 °C
Kontrol dan Peredupan	
Dapat diredupkan	Tidak
Mekanis dan Housing	
Lapisan bohlam	Suram
Bentuk Bohlam	Bentuk T

Informasi Umum

Order Code	Full Product Name	Tutup-Dasar	Nominal masa pakai
929002408808	TForce Core HB 50W E27 865 GN3	E27	15.000 jam
929002409308	TForce Core HB 80W E40 865 GN3	E40	25.000 jam
929002409708	TForce Core HB MV ND 65W E40 840 G3	E40	25.000 jam
929002408408	TForce Core HB 30W E27 865 GN3	E27	15.000 jam
929002406708	TForce Core HB MV ND 35W E27 840 G3	E27	15.000 jam
929002408608	TForce Core HB 40W E27 865 GN3	E27	15.000 jam
929002408208	TForce Core HB 25W E27 865 GN3	E27	15.000 jam
929002408908	TForce Core HB 50W E40 865 GN3	E40	15.000 jam
929002409108	TForce Core HB 65W E40 865 GN3	E40	25.000 jam

Teknis Lampu

Order Code	Full Product Name	Suhu Warna		
		Terkorelasi (Nom)	Kode Warna	Flux Cahaya
929002408808	TForce Core HB 50W E27 865 GN3	6500 K	865	5.000 lm
929002409308	TForce Core HB 80W E40 865 GN3	6500 K	865	9.000 lm
929002409708	TForce Core HB MV ND 65W E40 840 G3	4000 K	840	9.000 lm
929002408408	TForce Core HB 30W E27 865 GN3	6500 K	865	3.200 lm
929002406708	TForce Core HB MV ND 35W E27 840 G3	4000 K	840	5.000 lm

Order Code	Full Product Name	Suhu Warna		
		Terkorelasi (Nom)	Kode Warna	Flux Cahaya
929002408608	TForce Core HB 40W E27 865 GN3	6500 K	865	4.000 lm
929002408208	TForce Core HB 25W E27 865 GN3	6500 K	865	2.700 lm
929002408908	TForce Core HB 50W E40 865 GN3	6500 K	865	5.000 lm
929002409108	TForce Core HB 65W E40 865 GN3	6500 K	865	7.000 lm

TrueForce Core LED Industri dan Retail (Highbay – HPI/SON/HPL)

Pengoperasian dan Kelistrikan

Order Code	Full Product Name	Konsumsi Daya
929002408808	TForce Core HB 50W E27 865 GN3	50 W
929002409308	TForce Core HB 80W E40 865 GN3	80 W
929002409708	TForce Core HB MV ND 65W E40 840 G3	65 W
929002408408	TForce Core HB 30W E27 865 GN3	30 W
929002406708	TForce Core HB MV ND 35W E27 840 G3	35 W

Order Code	Full Product Name	Konsumsi Daya
929002408608	TForce Core HB 40W E27 865 GN3	40 W
929002408208	TForce Core HB 25W E27 865 GN3	25 W
929002408908	TForce Core HB 50W E40 865 GN3	50 W
929002409108	TForce Core HB 65W E40 865 GN3	65 W

Suhu

Order Code	Full Product Name	T-Case Maksimum (Nom)
929002408808	TForce Core HB 50W E27 865 GN3	78 °C
929002409308	TForce Core HB 80W E40 865 GN3	83 °C
929002409708	TForce Core HB MV ND 65W E40 840 G3	80 °C
929002408408	TForce Core HB 30W E27 865 GN3	75 °C
929002406708	TForce Core HB MV ND 35W E27 840 G3	76 °C

Order Code	Full Product Name	T-Case Maksimum (Nom)
929002408608	TForce Core HB 40W E27 865 GN3	79 °C
929002408208	TForce Core HB 25W E27 865 GN3	90 °C
929002408908	TForce Core HB 50W E40 865 GN3	78 °C
929002409108	TForce Core HB 65W E40 865 GN3	80 °C

Penyetujuan dan Aplikasi

Order Code	Full Product Name	Penggunaan Energi kWh/1000 h
929002408808	TForce Core HB 50W E27 865 GN3	- kWh
929002409308	TForce Core HB 80W E40 865 GN3	80 kWh
929002409708	TForce Core HB MV ND 65W E40 840 G3	65 kWh
929002408408	TForce Core HB 30W E27 865 GN3	- kWh
929002406708	TForce Core HB MV ND 35W E27 840 G3	35 kWh
929002408608	TForce Core HB 40W E27 865 GN3	- kWh
929002408208	TForce Core HB 25W E27 865 GN3	- kWh
929002408908	TForce Core HB 50W E40 865 GN3	- kWh
929002409108	TForce Core HB 65W E40 865 GN3	65 kWh

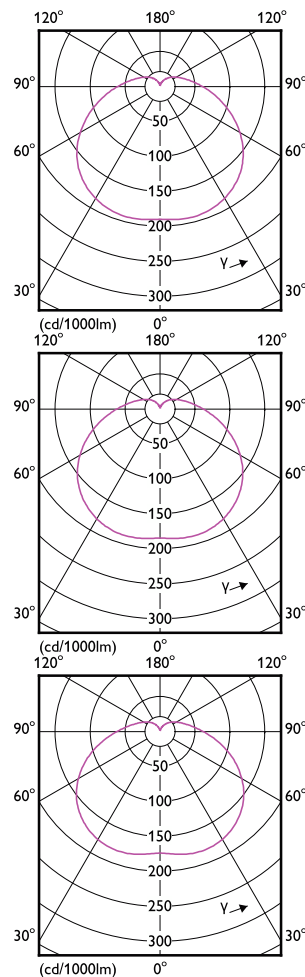
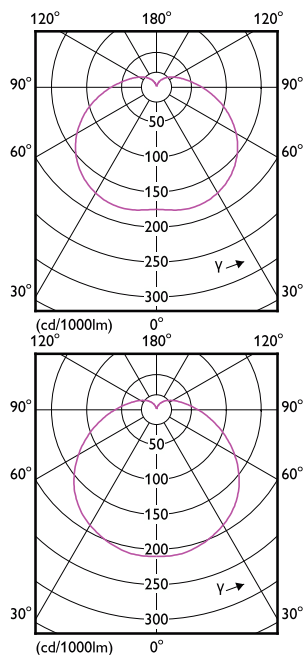

TrueForce Core LED Industri dan Retail (Highbay – HPI/SON/HPL)

